

# FROY

SUSPENSION LED

TYPE:

PROJECT NAME:







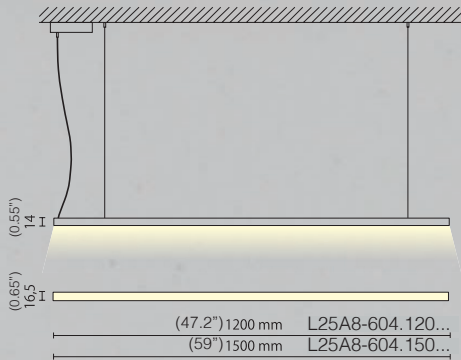



# FROY

SUSPENSION



Thin and airy, Froy is a hanging luminaire made from epoxy polyester powder coated aluminium. It is equipped with an opal diffuser, high efficiency LED modules and driver. The lamp is suspended with galvanized steel cables (not included) with quick-adjust regulation devices. Its degree of protection against the penetration of dust, solid objects and liquids is IP40.

-  105°
-  TC 3000K / 4000K
-  IP 40
-  CRI >80
-  EEI A+
-  RG 0
-  02 Matte black
-  09 Matte white
-  Intertek

SPECIFICATION SHEET

CODE	W	Lm (3000K)
L25A8-604.120...	30	3000
L25A8-604.150...	38	3750