

BASILICA™

SUSPENSION

TYPE:

PROJECT NAME:



BASILICA OG



BASILICA BALL

A symmetrical light form with proportions redolent of classical formal architecture. A hanging lamp featuring two parallel wings evocative of the vaults of one of the Venetian architect's Andrea Palladio greatest works. Design and aesthetic research are knowingly combined with performance.



SPECIFICATION SHEET

BASILICA™

SUSPENSION

TYPE:

PROJECT NAME:

	Dimensions	Light source	
Basilica 125	125 x 60 x 30 cm weight 20 Kg	lamp type 2 linear modules 48 W luminous efficacy 8070 Lm light color 3000 K uplight 2690 Lm downlight 5380 Lm	Velvet: L82BASESO125O01 Wool: L82BASESO125E01 Eco: L82BASESO125Q01
Basilica Ball 125	125 x 60 x 30 cm weight 20 Kg	lamp type 4 x E26 42 W + 2 x GU10 max watt 42 W HES	Velvet: L82BABESO125O01 Wool: L82BABESO125E01 Eco: L82BABESO125Q01

Basilica

Basilica Ball

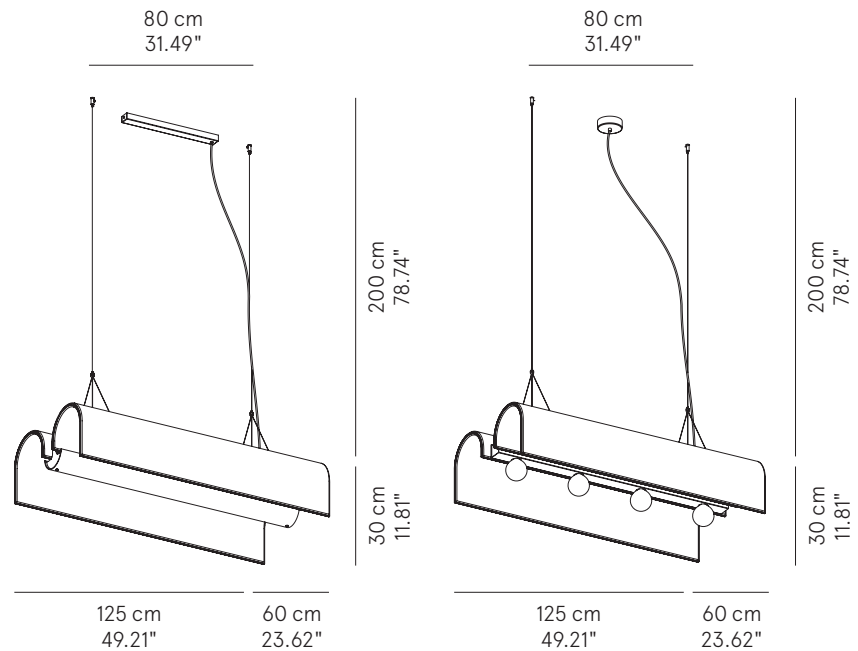

Finish

Diffuser textile



Velvet



Eco Friendly



Wool

Fabric lampshade,
metal structure

Uplight and
downlight: Up 2560
lm - Down 5120 lm

IP20



* on demand

** cable on measure

SPECIFICATION SHEET

ORDERING INFO

Model (Order Code)	Finish	LED	Driver Options
-	See page 3-4	<input type="radio"/> 2700K <input type="radio"/> 3000K <input type="radio"/> 4000K	<input type="radio"/> 120V Phase Dimming <input type="radio"/> 120V 0-10V Dimming <input type="radio"/> 277V 0-10V Dimming



Note: Basilica Ball (E26 + GU10) only available with 120V Phase Dimming.

BASILICA™

SUSPENSION

TYPE:

PROJECT NAME:



VELVET
100% polyester



ECO FRIENDLY
100% recycled post-consumer plastic
100% biodegradable by imNativ®



Code 455
Cream

Code 752
Rust

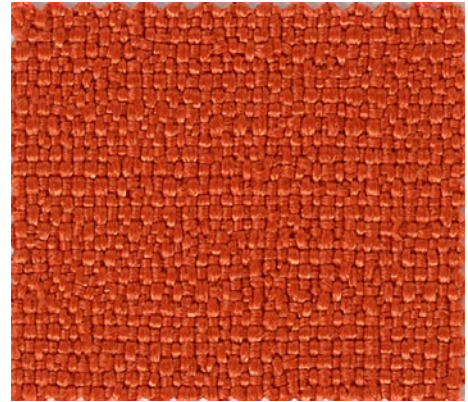

Code 456
Dove



Code 457
Mustard

Code 750
Ivory

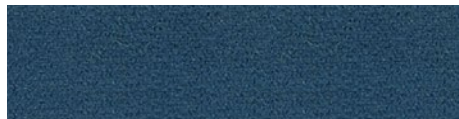

Code 458
Cornflower

Code 751
Sage



Code 459
Sherwood

Code 753
Sugar paper

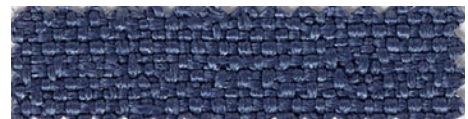

Code 460
Rust

Code 754
Dark grey

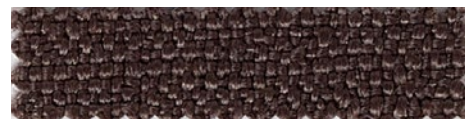

Code 461
Purple red

Code 755
Hazel



Code 462
Ocean blue

Code 756
Ocher



Code 463
Light grey

Code 464
Anthracite

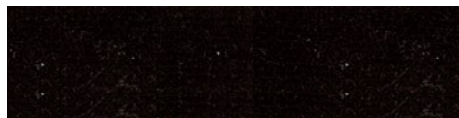

SPECIFICATION SHEET

BASILICA™

SUSPENSION

TYPE:

PROJECT NAME:



WOOL
70% wool
30% polyamide



Code 650

Sand

Code 652

Green

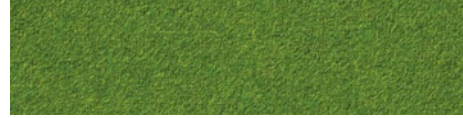

Code 660

Dark green



Code 661

Curry

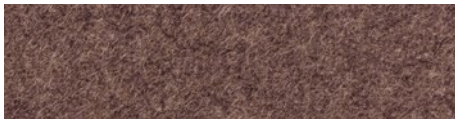

Code 659

Chestnut

Code 662

Turquoise

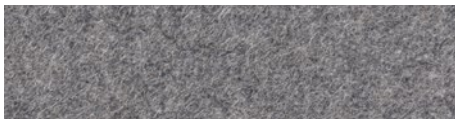
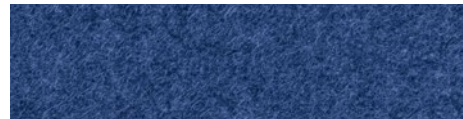

Code 658

Grey

Code 655

Avio blue

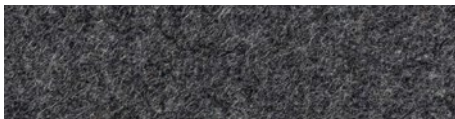

Code 656

Dark grey

Code 654

Purple

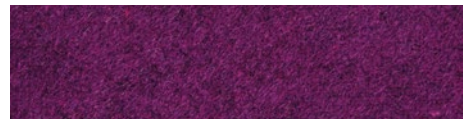

Code 651

Orange

Code 657

Cardinal red



Code 653

Mustard yellow

SPECIFICATION SHEET