

BIG BANG™ 4

Ceiling

TYPE:

PROJECT NAME:

design by Alain Monnens



Spot collection with an emphasis on technique and mobility. Every part has a definite function, which provides for a candid and non-intrusive design. Because of this, BANG fits in any possible environment, which makes application easy. In brushed aluminium finish, Bang creates a bold 'industrial' impression. Then again, in enamel finish, its elegant fluent lines are emphasised. BANG is available for 12V or 120V dicroid lamps.

SPECIFICATION SHEET

Luminart®

WWW.LUMINARTLIGHTING.COM

BIG BANG™ 4

Ceiling

TYPE:

PROJECT NAME:

big bang 4 AR111 base H15 mm



brushed aluminium
grey painted
white painted
black painted

T41C2HAB
T41C2HGL
T41C2HWL
T41C2HZL

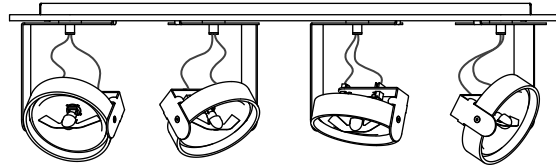
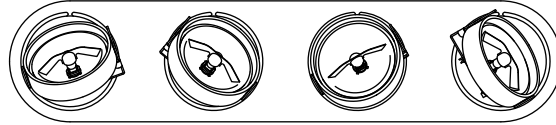

730 28.74"
650 25.59"

0.59"
15
6.02"
153
3.15"
80
6.30"
160

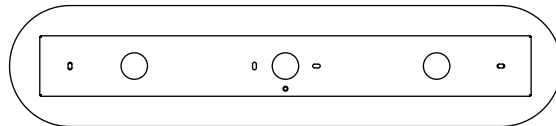

big bang 4 AR111 base H40 mm

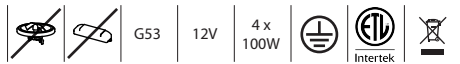

brushed aluminium
grey painted
white painted
black painted

T41C3HAB
T41C3HGL
T41C3HWL
T41C3HZL

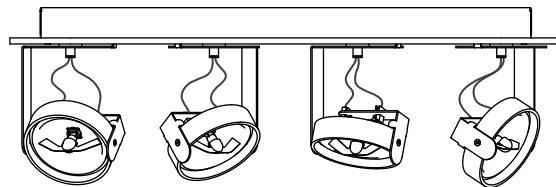
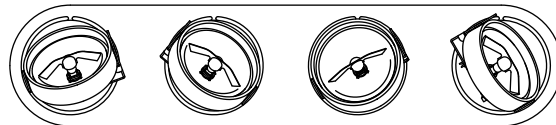

730 28.74"
650 25.59"

1.57"
40
6.02"
153
3.15"
80
6.30"
160

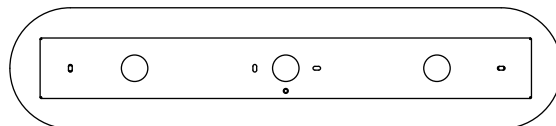

BIG BANG™ 4

Ceiling

TYPE:

PROJECT NAME:

big bang 4 CDMR111



brushed aluminium
grey painted
white painted
black painted

T41C4OAB
T41C4OGL
T41C4OWL
T41C4OZL

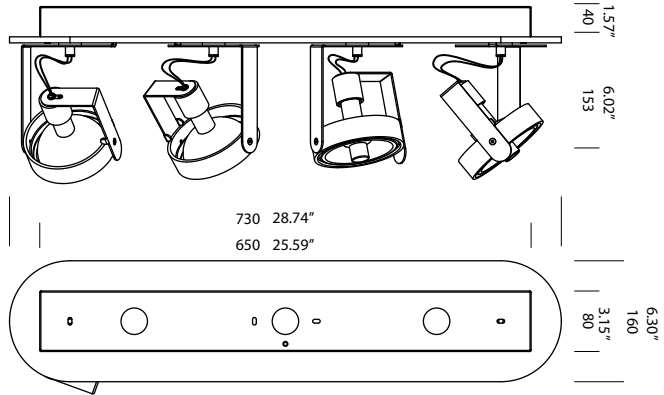
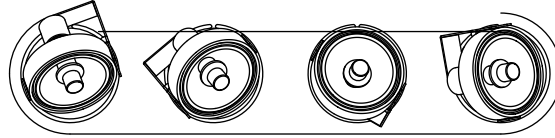

big bang 4 CDMR111



brushed aluminium
grey painted
white painted
black painted

T41C5OAB
T41C5OGL
T41C5OWL
T41C5OZL

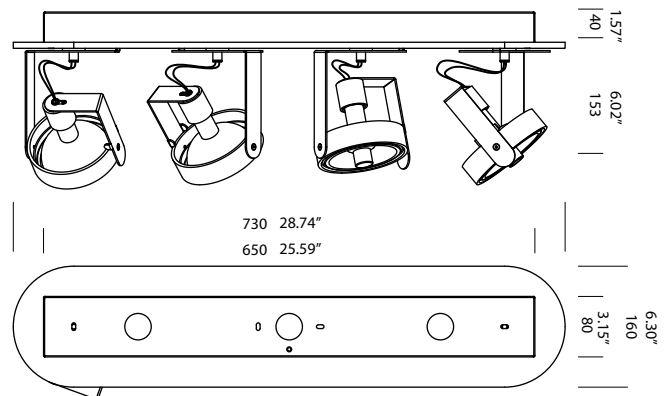
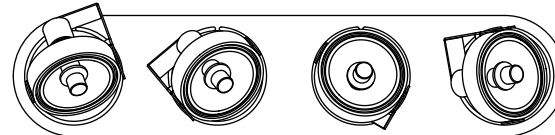

SPECIFICATION SHEET

BIG BANG™ 4

Ceiling

TYPE:

PROJECT NAME:

big bang 4 ES111



brushed aluminium
grey painted
white painted
black painted

T41C1HAB
T41C1HGL
T41C1HWL
T41C1HZL

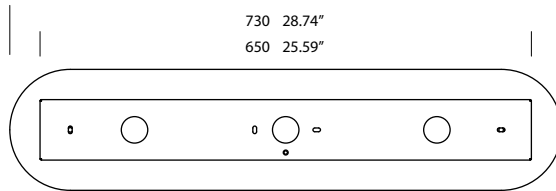
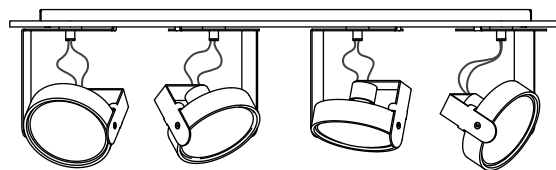
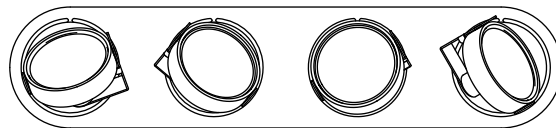

0.59"
15
6.02"
153
6.30"
160
3.15"
80

730 28.74"
650 25.59"