

BUSSOLED™

MONO-FINISH

TYPE:

PROJECT NAME:



■ BUSSOLED

Available in two different sizes and in multiple configurations, this hanging luminaire has a housing made from epoxy powder coated finish aluminum stabilized with UV rays and it is equipped with a Chip On Board technology high efficiency LED light source. Complete with cables for suspension in galvanized steel with a 1.2 mm diameter, 200 cm of electrical cable and ceiling attachment in painted steel. The degree of protection against the penetration of dust, solid objects and liquids is IP40.

SPECIFICATION SHEET

BUSSOLED™ SMALL



TYPE:

MONO-FINISH WITH BOTTOM DIFFUSER LENS

PROJECT NAME:

BUSSOLED SMALL MONO-FINISH WITH DIFFUSER LENS

code	W	Lm (3000K)	 Frosted white	lifetime
L258630.25...	25	3530	110°	75.000h L80/B10
L258630.37...	37	5165	110°	75.000h L80/B10

- SL  LED
- AL *included*
-  *(see table)*
- TC .30 per 3000K / .40 per 4000K
- IP 40
- CRI >80 (CRI93 and CRI97 on request)
- SDCM 3
- EEI A++
- RG 1
- 02 *Matte black*
- 08 *Frosted white*

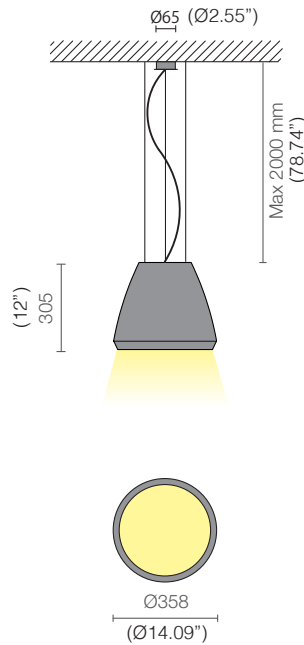

SPECIFICATION SHEET

ORDERING INFO

Model (Order Code)	Finish	LED	Remote Driver Options
	<input type="radio"/> 02 Matte black <input type="radio"/> 08 Frosted white	<input type="radio"/> 3000K <input type="radio"/> 4000K	<input type="radio"/> 120V Phase Dimming <input type="radio"/> 120V 0-10V Dimming <input type="radio"/> 277V 0-10V Dimming



Fixture comes with a 4" backplate that mounts to a standard junction box.

BUSSOLED™ SMALL



MONO-FINISH

TYPE:

PROJECT NAME:

BUSSOLED SMALL MONO-FINISH

code	W	Lm (3000K)	 <i>Frosted white</i>	lifetime
L258632.25...	25	3530	95°	75.000h L80/B10
L258632.37...	37	5165	95°	75.000h L80/B10

- SL  LED
- AL *included*
-  *(see table)*
- TC .30 per 3000K / .40 per 4000K
- IP 40
- CRI >80 (*CRI93 and CRI97 on request*)
- SDCM 3
- EEI A++
- RG 1
- 02 *Matte black*
- 08 *Frosted white*

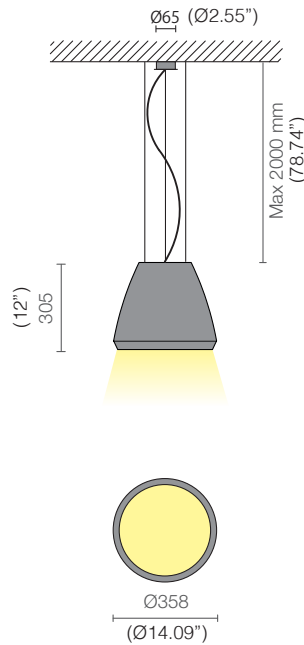

SPECIFICATION SHEET

ORDERING INFO

Model (Order Code)	Finish	LED	Remote Driver Options
	<input type="radio"/> 02 Matte black <input type="radio"/> 08 Frosted white	<input type="radio"/> 3000K <input type="radio"/> 4000K	<input type="radio"/> 120V Phase Dimming <input type="radio"/> 120V 0-10V Dimming <input type="radio"/> 277V 0-10V Dimming



Fixture comes with a 4" backplate that mounts to a standard junction box.

BUSSOLED™ LARGE



TYPE:

MONO-FINISH WITH BOTTOM DIFFUSER LENS

PROJECT NAME:

BUSSOLED LARGE MONO-FINISH WITH DIFFUSER LENS

code	W	Lm (3000K)	 Frosted white	lifetime
L258640.25...	25	3530	110°	75.000h L80/B10
L258640.37...	37	5165	110°	75.000h L80/B10

- SL  LED
- AL *included*
-  *(see table)*
- TC .30 per 3000K / .40 per 4000K
- IP 40
- CRI >80 (CRI93 and CRI97 on request)
- SDCM 3
- EEI A++
- RG 1
- 02 *Matte black*
- 08 *Frosted white*

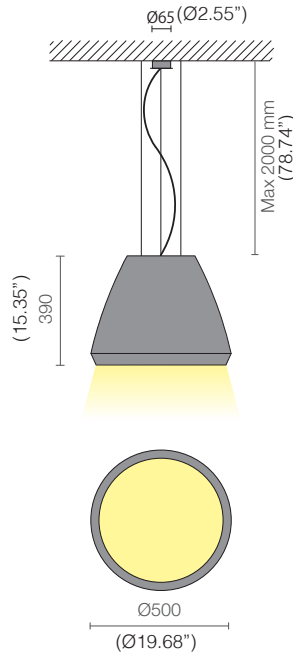

SPECIFICATION SHEET

ORDERING INFO

Model (Order Code)	Finish	LED	Remote Driver Options
	<input type="radio"/> 02 Matte black <input type="radio"/> 08 Frosted white	<input type="radio"/> 3000K <input type="radio"/> 4000K	<input type="radio"/> 120V Phase Dimming <input type="radio"/> 120V 0-10V Dimming <input type="radio"/> 277V 0-10V Dimming



Fixture comes with a 4" backplate that mounts to a standard junction box.

BUSSOLED™ LARGE



MONO-FINISH

TYPE:

PROJECT NAME:

BUSSOLED LARGE MONO-FINISH

code	W	Lm (3000K)	 Frosted white	lifetime
L258642.25...	25	3530	95°	75.000h L80/B10
L258642.37...	37	5165	95°	75.000h L80/B10
L258642.50...	50	7215	95°	60.000h L80/B10

SL	 LED
AL	included
	(see table)
TC	.30 per 3000K / .40 per 4000K
IP	40
CRI	>80 (CRI93 and CRI97 on request)
SDCM	3
EEL	A++
RG	1
02	Matte black
08	Frosted white

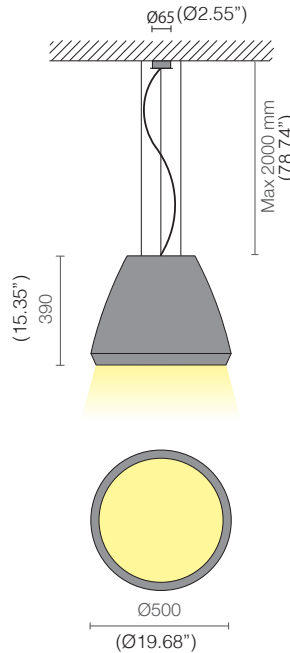

SPECIFICATION SHEET

ORDERING INFO

Model (Order Code)	Finish	LED	Remote Driver Options
	<input type="radio"/> 02 Matte black <input type="radio"/> 08 Frosted white	<input type="radio"/> 3000K <input type="radio"/> 4000K	<input type="radio"/> 120V Phase Dimming <input type="radio"/> 120V 0-10V Dimming <input type="radio"/> 277V 0-10V Dimming



Fixture comes with a 4" backplate that mounts to a standard junction box.