

CIRCUS™

ACOUSTIC SUSPENSION

TYPE:

PROJECT NAME:



Diffused light suspension fixture. Curved aluminum structure in matte black, white or painted gold. Built-in flexible LED strip and opal PMMA diffuser. Metal ceiling canopy in matte white, black or painted gold.

SPECIFICATION SHEET

ORDERING INFO

| Model (Order Code) | Structure Finish | Acoustic Fabric | LED | Remote Driver Options |
|--------------------|------------------------------------|-------------------|-----------------------------|--|
| | <input type="radio"/> Matte Black | <i>See page 4</i> | <input type="radio"/> 2700K | <input type="radio"/> 120V 0-10V Dimming |
| | <input type="radio"/> Matte White | | <input type="radio"/> 3000K | <input type="radio"/> 277V 0-10V Dimming |
| | <input type="radio"/> Painted Gold | | <input type="radio"/> 3500K | |
| | | | <input type="radio"/> 4000K | |



Luminart®

WWW.LUMINARTLIGHTING.COM

CIRCUS™

ACOUSTIC SUSPENSION

TYPE:

PROJECT NAME:

Circus Ø200 Downlight

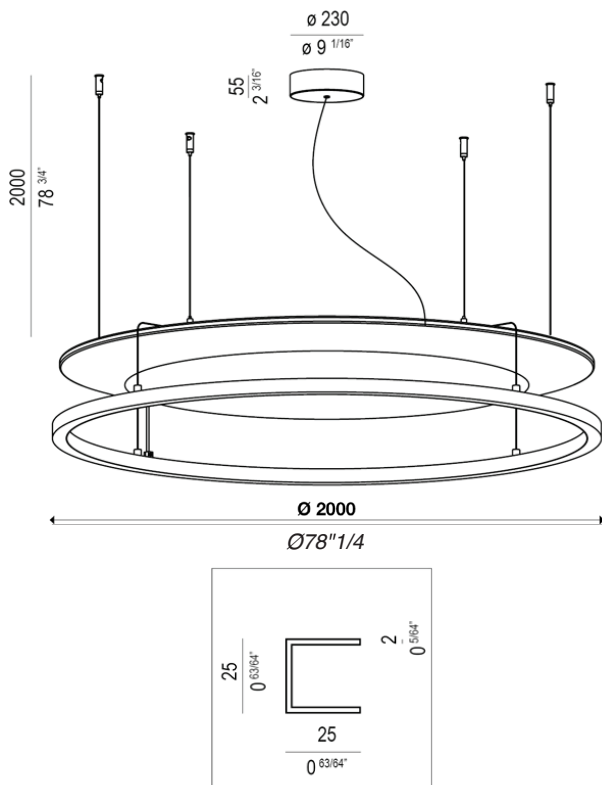

Circus Ø200 Uplight+Downlight

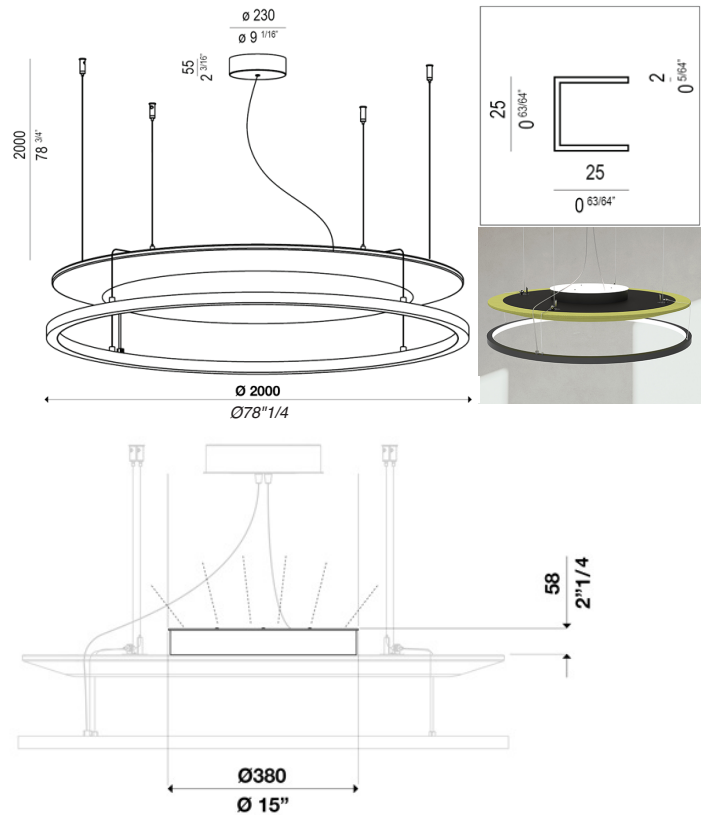

Model: L03S200DI

Description: Diffused light hanging luminaire for architectural lighting and acoustic control.

Application: Architectural indoor lighting

Materials: Aluminum structure, Opal PMMA diffuser

Structure Finishes: Matte black, matte white, painted gold

Acoustic Panel: Honeycomb polycarbonate acoustic panel with a removable cover in 100% polyester

Acoustic Fabric: See page 4

Light source: LED 153W, 24V, 19125 Lm. Downward emission. 80CRI. IP20.

Light control: Dimmable with 0-10V or TRIAC dimming

Model: L03S200INDI

Description: Diffused light hanging luminaire for architectural lighting and acoustic control.

Application: Architectural indoor lighting

Materials: Aluminum structure, Opal PMMA diffuser

Structure Finishes: Matte black, matte white, painted gold

Acoustic Panel: Honeycomb polycarbonate acoustic panel with a removable cover in 100% polyester

Acoustic Fabric: See page 4

Light source: LED (153W down, 17W up), 24V, (19125 Lm down, 2240 Lm up). Downward+Upward emission. (80CRI down, 90CRI up). IP20.

Light control: Dimmable with 0-10V or TRIAC dimming

SPECIFICATION SHEET

ORDERING INFO

| Model (Order Code) | Structure Finish | Acoustic Fabric | LED | Remote Driver Options |
|--------------------|--|-----------------|--|--|
| | <input type="radio"/> Matte Black <input type="radio"/> Matte White <input type="radio"/> Painted Gold | See page 4 | <input type="radio"/> 2700K <input type="radio"/> 3000K <input type="radio"/> 3500K <input type="radio"/> 4000K | <input type="radio"/> 120V 0-10V Dimming <input type="radio"/> 277V 0-10V Dimming |



Acoustic Panel Fabric Color Options

black
60999



white
60061



beige
61128



cool gray
60011

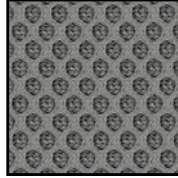

warm gray
60165

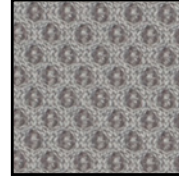

anthracite
60025



mole
61110



licorice
62064

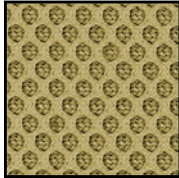

olive
68108

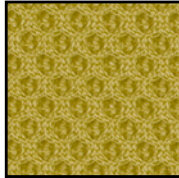

lime
61110

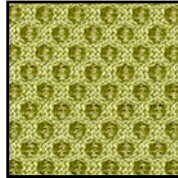

red
64119

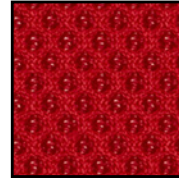

berry
64089



merlot
61130



tobacco
61129

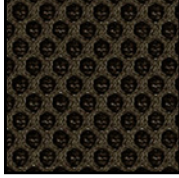

midnight
66064



navy
66123

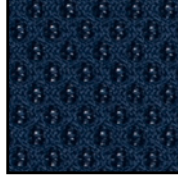

denim
66140

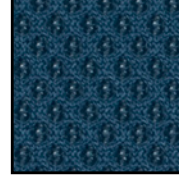

klein
66120

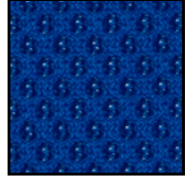

forest green
68110



green
68109



yellow
68137

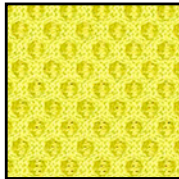

orange
64119



lilac
65078

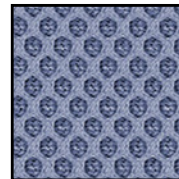

sky
66063

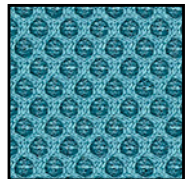

ORDERING INFO

Model (Order Code)

Structure Finish

Fabric Finish

LED

Remote Driver Options

- Matte Black
- Matte White
- Painted Gold

- 2700K
- 3000K
- 3500K
- 4000K

- 120V 0-10V Dimming
- 277V 0-10V Dimming

