

CLOCK™

SPOTLIGHT

TYPE:

PROJECT NAME:



Reduced thickness

Its 36 mm thickness for both diameters allows to fix CLOCK discreetly in outdoor settings.

The aluminum body rotates around the locking pin on the vertical surface to easily adjust its direction. An BMA screw locks it in place. Two eyelets on the base allow for a $\pm 40^\circ$ horizontal adjustment.



Sealed glass

The front tempered ultrawhite clear glass is sealed to the frame for a perfect watertight.



SPECIFICATION SHEET

Watertight wiring

CLOCK is hermetically sealed with a two-component resin and provided with a 1.5 m H05RN-F cable. The cable can pass through a special hole in the base of the arm.

- Brass cable gland
- Aquastop Resin Finish
- Anti-tear cable



CLOCK™

SPOTLIGHT

TYPE:

PROJECT NAME:

Light Fixtures

Clock Ø80mm

IP67 outdoor spotlight.
CRI>80.
1.5m buriable cable included.
For 7m cable, add MT7 to code.

Finish options: Graphite, Metallic Grey,
White, Corten

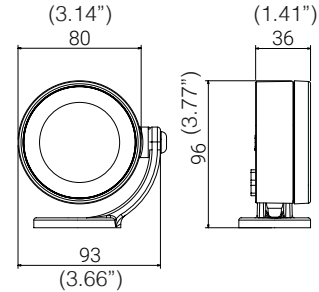

Code	Voltage	Wattage	LED Lumens	Real Lumens	Optics
L984661LV	24V	4	460	290	Standard 40° Add 12 to code for 12° Add 90 to code for 90°

Clock Ø120mm

IP67 outdoor spotlight.
CRI>80.
1.5m buriable cable included.
For 7m cable, add MT7 to code.

Finish options: Graphite, Metallic Grey,
White, Corten

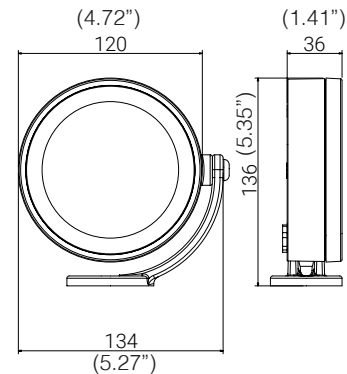

Code	Voltage	Wattage	LED Lumens	Real Lumens	Optics
L984664LV	24V	10	1100	750	Standard 40° Add 12 to code for 12° Add 90 to code for 90° Add HC to code for honeycomb optic
L984665LV	24V	15	1575	1050	Standard 40° Add 12 to code for 12° Add 90 to code for 90° Add HC to code for honeycomb optic

SPECIFICATION SHEET

Accessories

Visor for Clock Ø120

Painted aluminum
Code: L984669
Finish options: Graphite, Metallic Grey

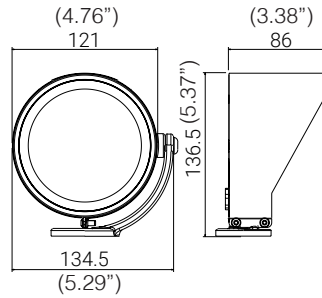

Garden spike

Polycarbonate. For mounting individual
lights as spotlight.
Code: L984691
Finish options: Graphite, Metallic Grey

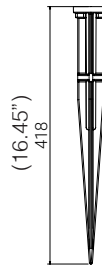

Waterproof connectors

Single connector IP68
Code: L981941

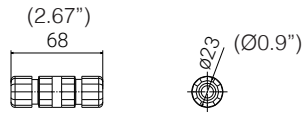

Through wiring connector IP68
Code: L981942

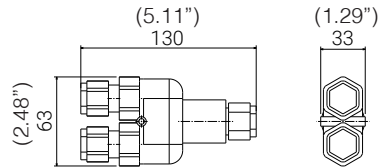

Up to 4 outputs connector IP68, based on
two component silicon gel
Code: L981944

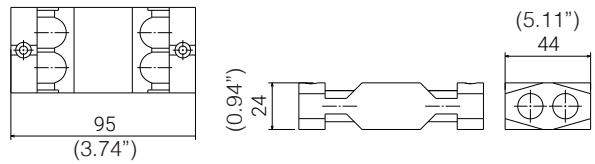

CLOCKTM

SPOTLIGHT

TYPE:

PROJECT NAME:

ORDERING INFO

LIGHT FIXTURES:

Order Code	Finish	LED	Remote Driver Options
	<input type="radio"/> Graphite <input type="radio"/> Metallic Grey <input type="radio"/> White <input type="radio"/> Corten	<input type="radio"/> 27K (2700K) <input type="radio"/> 3K (3000K) <input type="radio"/> 4K (4000K)	<input type="radio"/> 120V Phase Dimming <input type="radio"/> 120V 0-10V Dimming <input type="radio"/> 277V 0-10V Dimming

ACCESSORIES:

Order Code	Finish (if applicable)

SPECIFICATION SHEET



Luminart[®]