

CLOCK™

WALL MOUNTED SPOTLIGHT

TYPE:

PROJECT NAME:



SPECIFICATION SHEET

CLOCK™

WALL MOUNTED SPOTLIGHT

TYPE:

PROJECT NAME:

Light Fixtures

Clock Ø80mm

IP67 outdoor spotlight.
CRI>80.
1.5m buriable cable included.
For 7m cable, add MT7 to code.

Finish options: Graphite, Metallic Grey,
White, Corten

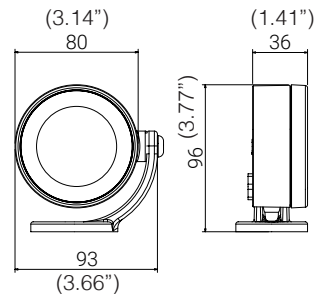

Code	Voltage	Wattage	LED Lumens	Real Lumens	Optics
L984661LV	24V	4	460	290	Standard 40° Add 12 to code for 12° Add 90 to code for 90°

Clock Ø120mm

IP67 outdoor spotlight.
CRI>80.
1.5m buriable cable included.
For 7m cable, add MT7 to code.

Finish options: Graphite, Metallic Grey,
White, Corten

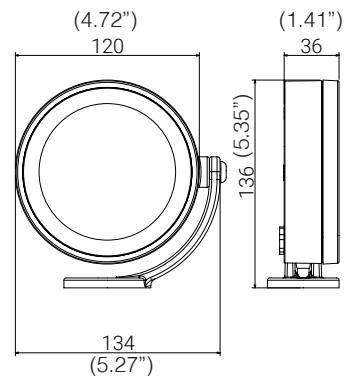

Code	Voltage	Wattage	LED Lumens	Real Lumens	Optics
L984664LV	24V	10	1100	750	Standard 40° Add 12 to code for 12° Add 90 to code for 90° Add HC to code for honeycomb optic
L984665LV	24V	15	1575	1050	Standard 40° Add 12 to code for 12° Add 90 to code for 90° Add HC to code for honeycomb optic

SPECIFICATION SHEET

CLOCK™

WALL MOUNTED SPOTLIGHT

TYPE:

PROJECT NAME:

Accessories

Visor for Clock Ø120

Painted aluminum

Code: L984669

Finish options: Graphite, Metallic Grey

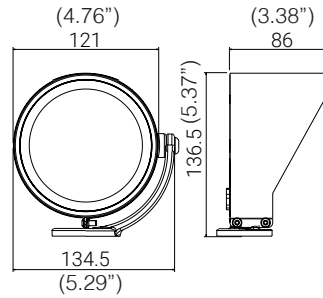

Wall mounting arm

Painted aluminum

Code: L984692

Finish options: Graphite, Metallic Grey

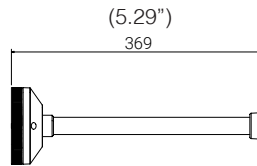

CLOCK™

WALL MOUNTED SPOTLIGHT

TYPE:

PROJECT NAME:

Waterproof connectors

Single connector IP68
Code: L981941

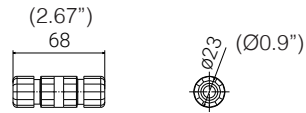

Through wiring connector IP68
Code: L981942

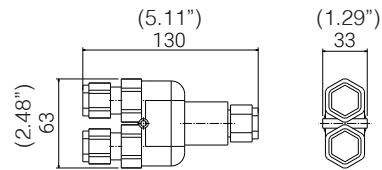

Up to 4 outputs connector IP68, based on
two component silicon gel
Code: L981944

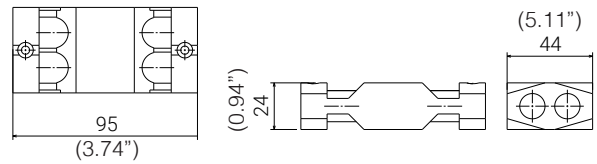

SPECIFICATION SHEET

CLOCK™





WALL MOUNTED SPOTLIGHT

TYPE:

PROJECT NAME:

ORDERING INFO

LIGHT FIXTURES:

Order Code	Finish	LED	Integral Driver Options
	<input type="radio"/>  Graphite	<input type="radio"/> 27K (2700K)	<input type="radio"/> 120V Phase Dimming
	<input type="radio"/>  Metallic Grey	<input type="radio"/> 3K (3000K)	
	<input type="radio"/>  White	<input type="radio"/> 4K (4000K)	
	<input type="radio"/>  Corten		

ACCESSORIES:

Order Code	Finish (if applicable)

SPECIFICATION SHEET

