

ELEMENT™ PLUS MEDIUM TYPE:

RECESSED

PROJECT NAME:

ORDERING INFO

Model	Housing	Output	LED	Optic	Voltage	Finish	Dimming
<input type="radio"/> L46621: Square, fixed, with trim	<i>See below</i>	<input type="radio"/> 15.5W	<input type="radio"/> 27K (2700K)	<input type="radio"/> Fixed Spot (20°)	<input type="radio"/> 120V	<i>See below</i>	<input type="radio"/> LTE (Leading/Trailing Edge Dim)
<input type="radio"/> L46611: Round, fixed, with trim		<input type="radio"/> 21.5W	<input type="radio"/> 30K (3000K)	<input type="radio"/> Fixed Flood (40°)	<input type="radio"/> 277V		<input type="radio"/> 010V (0-10V)
<input type="radio"/> L46622: Square, adjust., with trim		<input type="radio"/> 29W	<input type="radio"/> 35K (3500K)	<input type="radio"/> Adjustable Spot (20°)			
<input type="radio"/> L46612: Round, adjust., with trim		<input type="radio"/> 40K (4000K)	<input type="radio"/> Adjustable Flood (40°)				
<input type="radio"/> L46641: Square, fixed, trimless*							
<input type="radio"/> L46631: Round, fixed, trimless*							
<input type="radio"/> L46642: Square, adjust., trimless*							
<input type="radio"/> L46632: Round, adjust., trimless*							

*Trimless models must be ordered with trimless finish option

HOUSING OPTION

Housing

- RF: Retrofit (no housing)
- NC: New construction plaster frame
- IC: Insulated ceiling housing
- CP: Chicago plenum housing

FINISH OPTION

Finish
First color indicates trim, second indicates reflector

White Trim Options

- 01: White/White
- 21: White/Black
- 41: White/Gold
- 13: White/Aluminum

Black Trim Options

- 23: Black/White
- 02: Black/Black
- 42: Black/Gold
- 33: Black/Aluminum

Grey Trim Options

- 20: Grey/White
- 22: Grey/Black
- 40: Gray/Gold
- 03: Gray/Aluminum

Trimless Options

- 01: Trimless/White
- 02: Trimless/Black
- 43: Trimless/Gold
- 51: Trimless/Aluminum

Fixed, With Trim

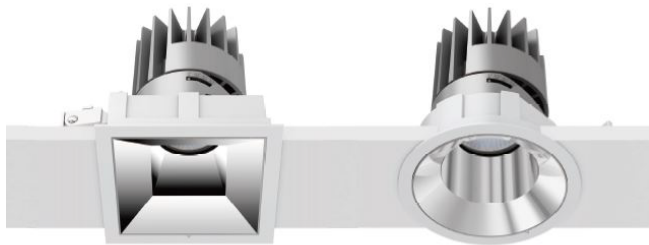

Adjustable, With Trim

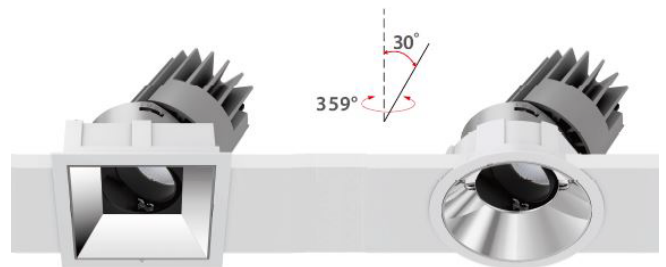

Fixed, Trimless

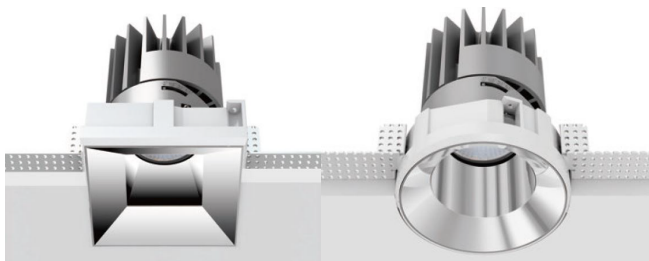

Adjustable, Trimless

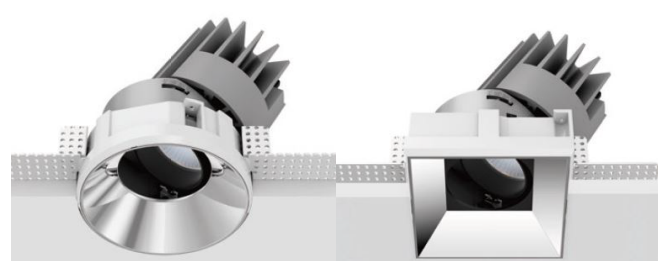

SPECIFICATION SHEET

LEDOLOGY®

WWW.LEDOLOGY.COM

A Luminart BRAND

ELEMENT™ PLUS MEDIUM TYPE:

RECESSED

PROJECT NAME:

GENERAL INFO

Specification grade downlights for architectural applications, with build quality and features for professional applications. 5" aperture.

Luminaire characteristics:

Power input: 15.5W, 21.5W or 29W

Lumens: 900, 1200 or 1600lm

Luminaire efficacy: Up to 67lm/W

Source:

COB LED module (LM-80 tested)

2700K : 90CRI or 97CRI,

3000K : 80CRI, 90CRI, or 97CRI,

3500K : 80CRI or 90CRI,

4000K : 80CRI.

Lumen maintenance:

LM79 tested,

90% of initial lumens at 50 000 hours (L90), 80% of initial lumens at 100 000 hours (L80).

Optic:

Fixed: Deep recessed reflector available with spot or flood optic.

Adjustable: Deep recessed reflector available with spot or flood optic. Optical assembly hot aiming adjustment: 30° tilt and 359° pan.

Material:

Body: Die-cast aluminum optical assembly

Reflector: Metalized polycarbonate

Baffle: Painted polycarbonate

Mounting:

See housing options, page 1. For detailed information see page 5.

Electrical:

Integral high efficiency power supply rated at 50 000 hours, 120V or 277V.

Dimming:

Leading edge (triac), Trailing edge (elv) and 0-10V down to 15%

0-10V down to 1%

Finish:

Powder coated body and baffle. See finish options, page 1.

Weight:

3.8lbs (1.72kg)

Warranty:

5 year limited warranty

Rating:

IP54

Certification:

cULus listed for Damp location.

SPECIFICATION SHEET

LEDOLOGY®

WWW.LEDOLOGY.COM

A **Luminart** BRAND

ELEMENT™ PLUS MEDIUM TYPE:

RECESSED

PROJECT NAME:

46621: Square, Fixed, With Trim

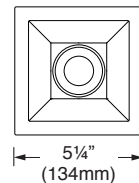
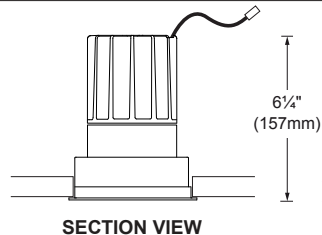
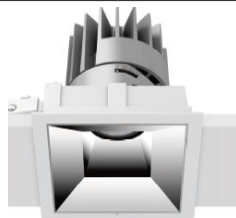

SECTION VIEW

BOTTOM VIEW

46611: Round, Fixed, With Trim

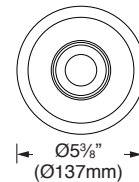
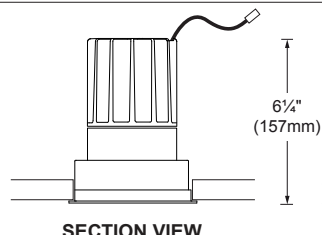

SECTION VIEW

BOTTOM VIEW

46641: Square, Fixed, Trimless

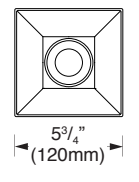
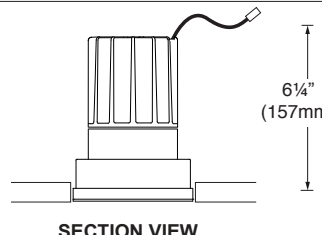
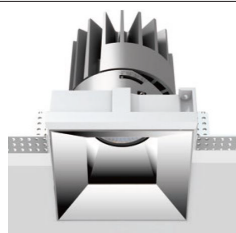

SECTION VIEW

BOTTOM VIEW

46631: Round, Fixed, Trimless

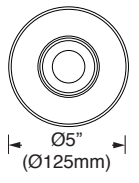
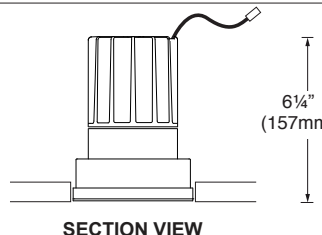

SECTION VIEW

BOTTOM VIEW

PHOTOMETRIC DATA

FIXED



CCT (K)	CRI	OUTPUT (W)	LOAD (W)	OPTIC	LUMENS (lm)	EFFICACY (lm/w)	MAX CANDELA (cd)
3000K	80	HE	15.5W	Spot	1040	67	5 535
				Flood	900	58	1 870
		BO	21.5W	Spot	1330	61	7 095
				Flood	1155	53	2 395
		HO	29W	Spot	1810	62	9 630
				Flood	1570	54	3 255

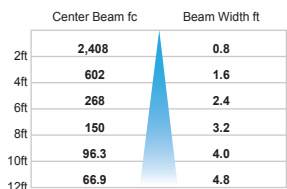

3000K - 80 CRI - 29W - Spot 20°

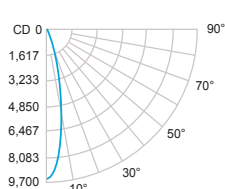

3000K - 80 CRI - 29W - Flood 40°

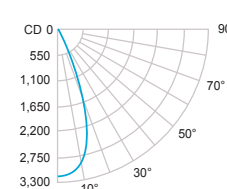

3000K - 80 CRI - 29W - Flood 40°

SPECIFICATION SHEET

LEDODOLOGY®

WWW.LEDOLOGY.COM

A Luminart BRAND

ELEMENT™ PLUS MEDIUM TYPE:

RECESSED

PROJECT NAME:

46622: Square, Adjustable, With Trim

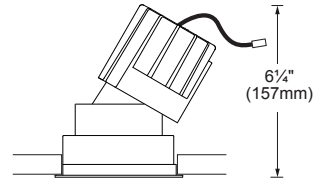

SECTION VIEW

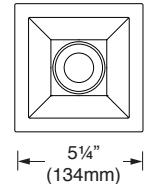

BOTTOM VIEW

46612: Round, Adjustable, With Trim

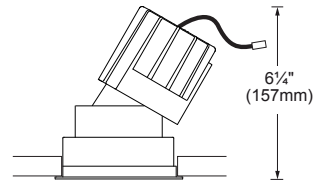

SECTION VIEW

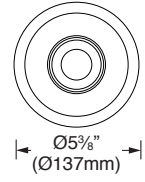

BOTTOM VIEW

46642: Square, Adjustable, Trimless

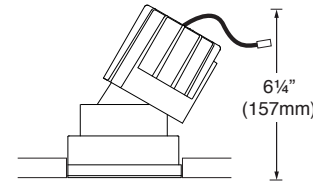
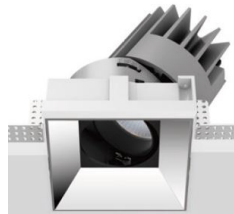

SECTION VIEW

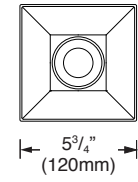

BOTTOM VIEW

46632: Round, Adjustable, Trimless

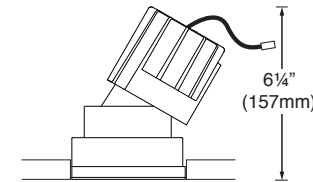

SECTION VIEW



BOTTOM VIEW

PHOTOMETRIC DATA

CCT (K)	CRI	OUTPUT	LOAD (W)	OPTIC	LUMENS (lm)	EFFICACY (lm / w)	MAX CANDELA (cd)
3000K	80	HE	15.5W	Spot	1040	67	5 535
				Flood	900	58	1 870
		BO	21.5W	Spot	1330	61	7 095
				Flood	1155	53	2 395
		HO	29W	Spot	1810	62	9 630
				Flood	1570	54	3 255

ADJUSTABLE



SPECIFICATION SHEET

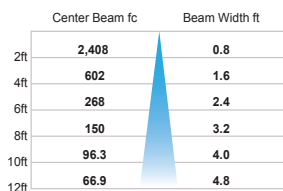

3000K - 80 CRI - 29W - Spot 20°

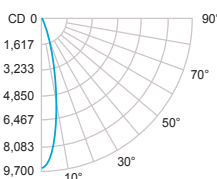

■ -0° H

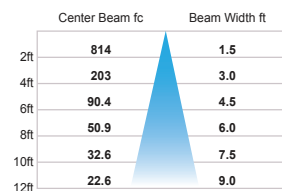

3000K - 80 CRI - 29W - Flood 40°

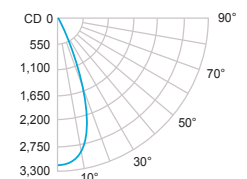

■ -0° H

LEDOLOGY®

WWW.LEDOLOGY.COM

A Luminart BRAND

ELEMENT™ PLUS MEDIUM TYPE:

RECESSED

PROJECT NAME:

Remodel (RF)

For new or existing ceiling. Suitable for non-insulated ceiling like sheetrock or paneling. Trimless frame kit can be shipped separately.

Minimum ceiling clearance: 7½" (190mm)

Ceiling thickness: ½" to 1¼" (3mm - 32mm)

Total weight: 3.8lbs (1.72kg)

Cut-out:

Round: Trim: Ø 5" (Ø 125mm)

Trimless: Ø 5½" (Ø 130mm)

Square: Trim: 4⅞" x 4⅞" (122 x 122mm)

Trimless: 5" x 5" (125 x 125mm)

Trimless frame kit codes:

Round: RT-M-R-TL

Square: RT-M-S-TL

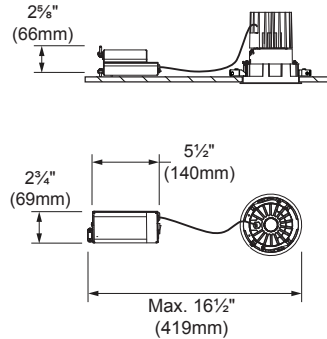

New construction with plaster frame (NC)

Plaster frame with hanger bars system to be installed during rough-in phase. Suitable for non-insulated new construction ceiling assemblies, like sheetrock, acoustic tiles, or paneling. Plaster frame and trimless frame kit can be shipped separately.

Minimum ceiling clearance: 7½" (190mm)

Ceiling thickness: ½" to 1¼" (3mm - 32mm)

Total weight: 5lbs (2.27kg)

Cut-out:

Round: Trim: Ø 5" (Ø 125mm)

Trimless: Ø 5½" (Ø 130mm)

Square: Trim: 4⅞" x 4⅞" (122 x 122mm)

Trimless: 5" x 5" (125 x 125mm)

Plaster frame codes:

Round: Trim: NC-M-RT

Trimless: NC-M-RTL

Square: Trim: NC-M-ST

Trimless: NC-M-STL

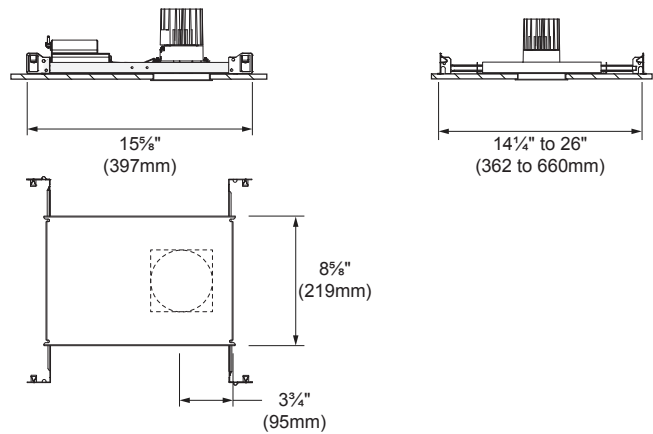

New construction with housing suitable for insulated ceiling (IC) or chicago plenum (CP)

Housing with hanger bars system for new construction installations. Suitable for insulated ceiling or Chicago Plenum applications. Housing and trimless frame kit can be shipped separately.

Minimum ceiling clearance: 8½" (216mm)

Ceiling thickness: ½" to 1¼" (3mm - 32mm)

Total weight: 13.75lbs (6.23kg)

Cut-out:

Round: Trim: Ø 5" (Ø 125mm)

Trimless: Ø 5½" (Ø 130mm)

Square: Trim: 4⅞" x 4⅞" (122 x 122mm)

Trimless: 5" x 5" (125 x 125mm)

Housing codes:

Round: Trim: IC-M-RT

Trimless: IC-M-RTL

Square: Trim: IC-M-ST

Trimless: IC-M-STL

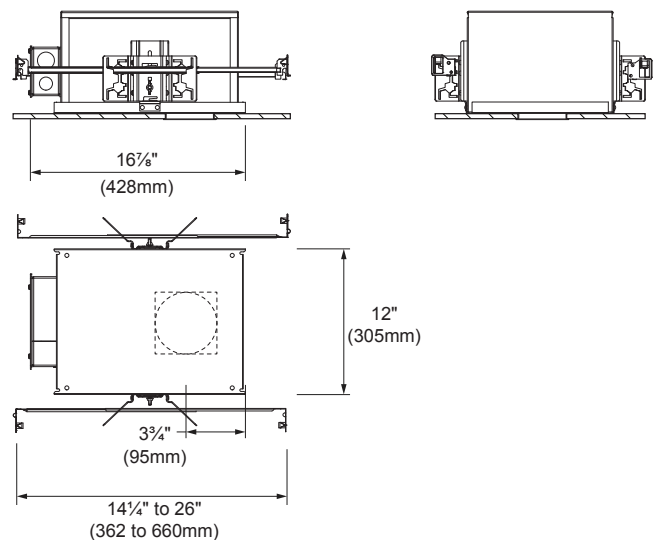

SPECIFICATION SHEET

LEDOLOGY®

WWW.LEDOLOGY.COM

A Luminart BRAND