

EVER AND EVER™

RECESSED

TYPE:

PROJECT NAME:

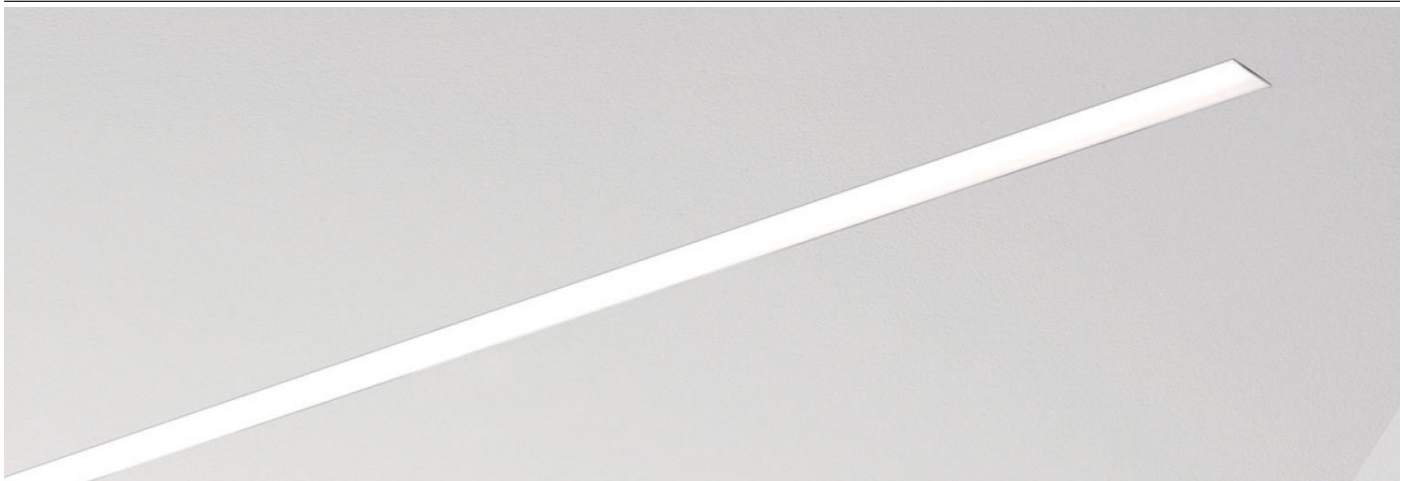

ORDERING INFO

Model	Length	Direct	LED	Body Finish	Diffuser	Dimming	Voltage
○ L4502	○ 02: 2'	○ 5W/FT	○ 30K (3000K)	○ 01: White	○ FD (Frosted)	○ LTE (Leading/ Trailing Edge Dim)	○ 120V
	○ 03: 3'	○ 7.5W/FT		○ 02: Black			
	○ 04: 4'	○ 10.5W/FT	○ 35K (3500K)	○ 10: Grey			
	○ 06: 6'	○ Empty	○ 40K (4000K)		○ 010V (0-10V)		
	○ 08: 8'						
	○ 16: 16'						
	○ 24: 24'						

SPECIFICATIONS

Design

Slim recessed luminaire provides direct lighting. Available as single modules or continuous runs suitable for interior application where general lighting is required.

Construction

Body: Extruded aluminum profile with die-cast end caps. Diffuser: PMMA frosted acrylic.
Mounting: Steel brackets.

Light Source

High efficiency Osram Duris®E5 JDSR (LM-80 tested) 3000K /3500K /4000K 85 cri typical (min>80CRI). Lumen maintenance: 70% of initial lumens at 100 000 hours (L70).

Optics

General lighting optics.

Electrical

High efficiency electronic power supply, rated 100 000 hours 120-277V.

Dimming

Standard power supply compatible with 0-10V and optional Hi-lume® BUS supply dimming.

Mounting

Recessed installation using included brackets. Maximum ceiling thickness of 0.98"(25mm).

Finish

White RAL9003, black RAL9004 or gray RAL9006.

SPECIFICATION SHEET

Luminart®

WWW.LUMINARTLIGHTING.COM

EVER AND EVER™

RECESSED

TYPE:

PROJECT NAME:

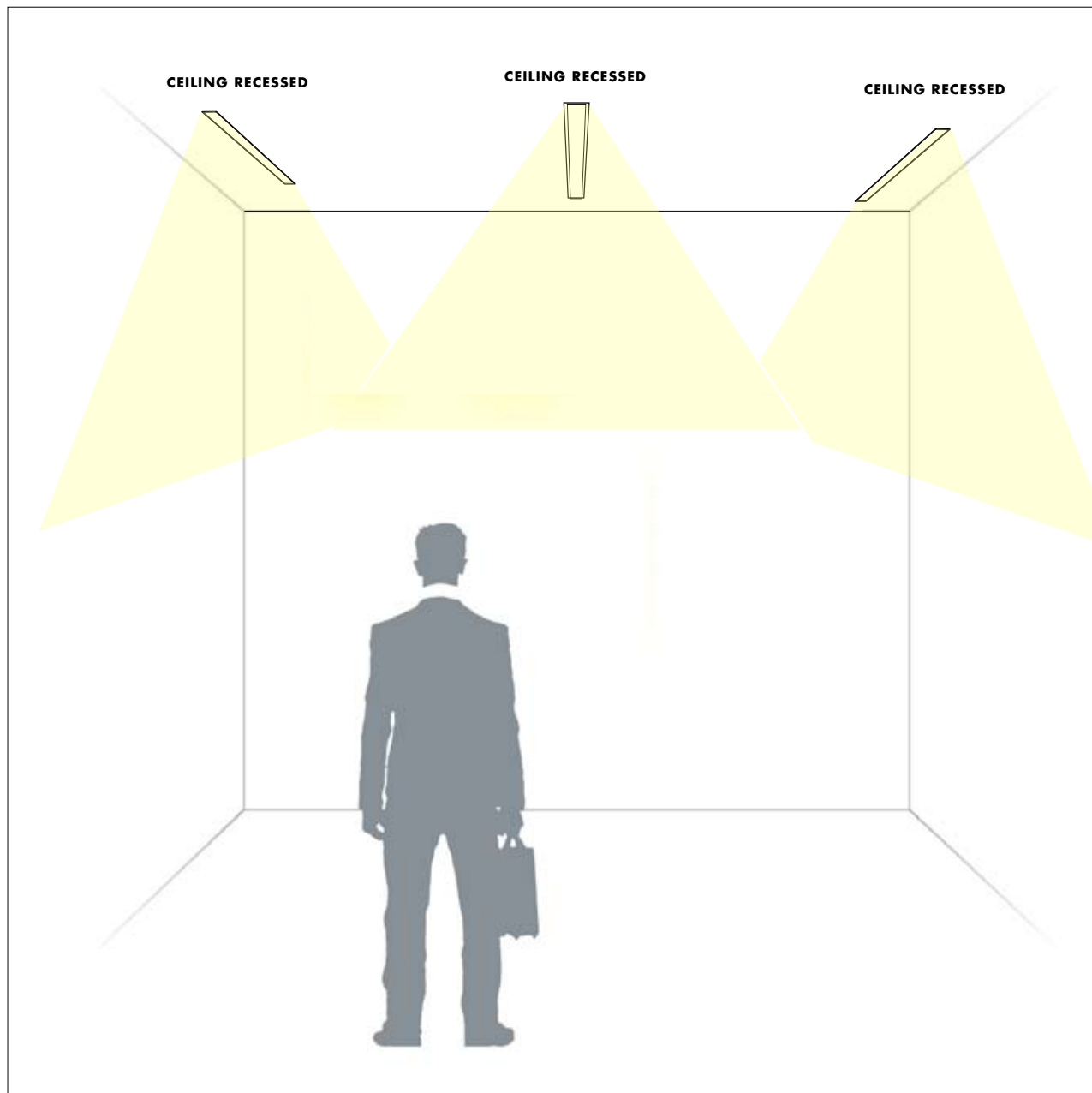

SPECIFICATION SHEET

EVER AND EVER™

RECESSED

TYPE:

PROJECT NAME:

LENGTH

Nominal length	Actual length A	Cut-out B
02	1'-11 ³ / ₈ "	1 ³ / ₄ " x 1'-11 ¹ / ₄ "
03	2'-11 ¹ / ₄ "	1 ³ / ₄ " x 2'-11 ¹ / ₈ "
04	3'-11"	1 ³ / ₄ " x 3'-10 ⁷ / ₈ "
06	5'-11"	1 ³ / ₄ " x 5'-10 ⁷ / ₈ "
08	7'-11"	1 ³ / ₄ " x 7'-10 ⁷ / ₈ "
12*	11'-9 ³ / ₈ "	1 ³ / ₄ " x 11'-9 ¹ / ₄ "
16*	15'-9 ³ / ₈ "	1 ³ / ₄ " x 15'-9 ¹ / ₄ "
24*	23'-7 ⁷ / ₈ "	1 ³ / ₄ " x 23'-7 ³ / ₄ "

The luminaire runs can be manufactured in most lengths with 12" increments. Contact factory for precise lengths and anchoring point details.

*Note that a visible 1/4" joint is used for lengths greater than 8'.

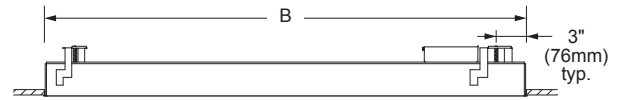
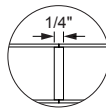

FRONT VIEW

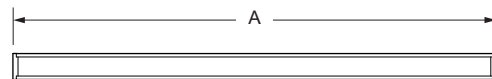

BOTTOM VIEW

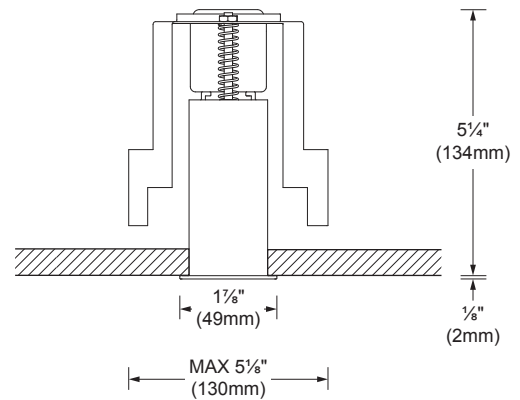

DETAIL VIEW

DIRECT OUTPUT

	LOAD	3000K	
	W/ft	lm/ft	lm/W
5W (Base output)	5	310	62
7.5W (Medium output)	7.5	455	60
10.5W (High output)	10.5	585	55

SPECIFICATION SHEET

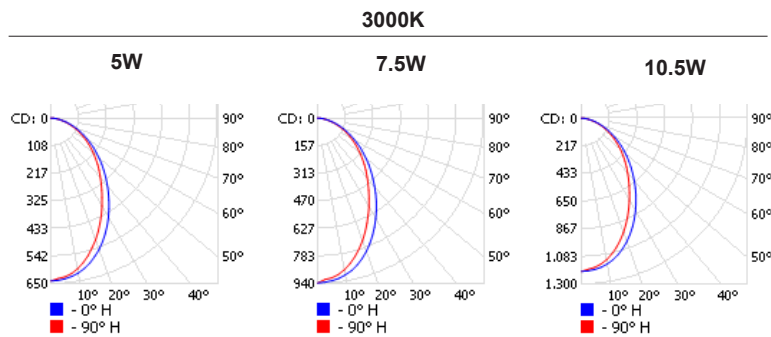

MULTIPLIER TABLE

Color options	Multiplier
3000K - 85CRI	1
3500K - 85CRI	1,09
4000K - 85CRI	1,19