

FLOAT™ RING

SUSPENSION

TYPE:

PROJECT NAME:



SPECIFICATION SHEET

Luminart®

WWW.LUMINARTLIGHTING.COM
Last updated: 07/10/24

FLOAT™ RING M800

SUSPENSION

TYPE:

PROJECT NAME:



Float
ringlight 800

Measurements:

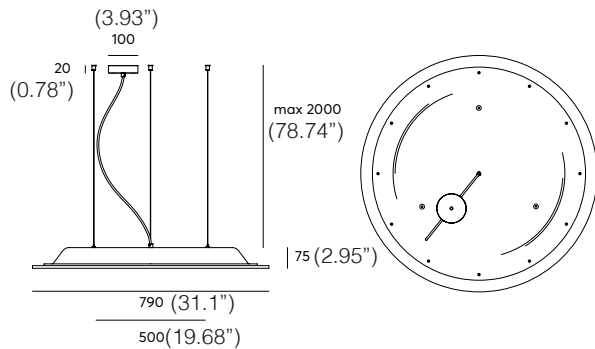

Material:

PET Felt (polyethylene terephthalate)

Fixture:

2m (78.74") black textile cable

3 black metal wires with adjustable griplock

Black ceiling cap and Charcoal PET Felt hood (standard)

Acoustic properties:



High absorption
value of aw 0,55

Pattern options:

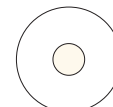

None

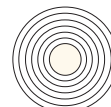

Circles

Total weight gross | net:

3,4 | 2,9kg

SPECIFICATION SHEET

ORDERING INFO

Model (Order Code)	Acoustic Finish Options	Pattern Options	LED	Dimming Options
<input type="radio"/> L77FLOAT RING M800 Up&Downlight	<input type="radio"/> See Acoustic Finish Options on Next Page	<input type="radio"/> N: None	<input type="radio"/> 27: 2700K	<input type="radio"/> 120V LTE
<input type="radio"/> L77FLOAT RING M800 Downlight		<input type="radio"/> C: Circles	<input type="radio"/> 30: 3000K	<input type="radio"/> 120-277V 0-10V (Universal Voltage)
			<input type="radio"/> 40: 4000K	



FLOAT™ RING M800

SUSPENSION

TYPE:

PROJECT NAME:

Colors:



Light source specifications:



LED power: 30W
 Luminous Flux: 3050lm
 Frequency: 47-63Hz
 Power factor: 102lm/W
 Optics: Acrylic Opal Prism
 CRI: Ra>80
 UGR: <22
 Operating temperature: -20 ~ +45

Photometrics:

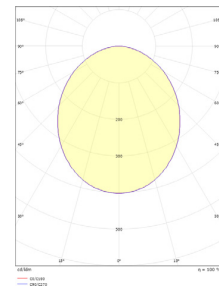

Lumen intensity distribution

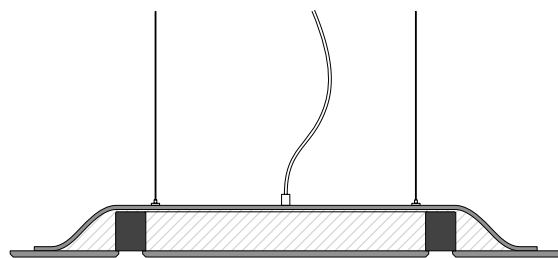

Acoustic specifications:

The acoustic design principle.



-  Acoustic PET Felt
-  Air
-  LED Element

The product is designed to have a double layer sound absorbing PET Felt with 60 mm. of air cavity in between. Due to the layered effect, soundwaves are optimally absorbed by the design.

The LED element will reflect the soundwaves

Measurement of sound absorption in a reverberation room According to ISO 354:2003.

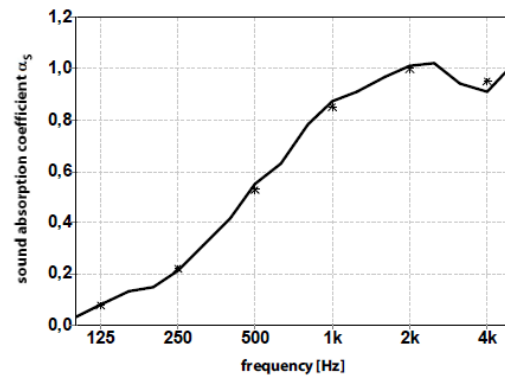

	0,03	0,15	0,42	0,78	0,97	0,94
1/3 oct.	0,08	0,21	0,55	0,87	1,01	0,91
	0,13	0,31	0,63	0,91	1,02	1,01
1/1 oct.	0,08	0,22	0,53	0,85	1,00	0,95

aw (ISO 11654) = 0,55(MH)

SAA (ASTM - C423) = 0,65

SPECIFICATION SHEET

FLOAT™ RING M800

SUSPENSION - UPLIGHT

TYPE:

PROJECT NAME:



Light source specifications:



LED power:	17W
Luminous Flux:	1870lm
Frequency:	47-63Hz
Power factor:	110lm/W
Optics:	Acrylic Opal Prism
CRI:	Ra>80
UGR:	<25
Operating temperature:	-20 ~ +45

Photometrics:

Lumen intensity distribution

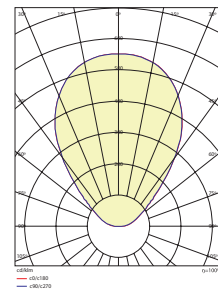

FLOAT™ RING L1200

SUSPENSION

TYPE:

PROJECT NAME:



Float
ringlight 1200

Measurements:

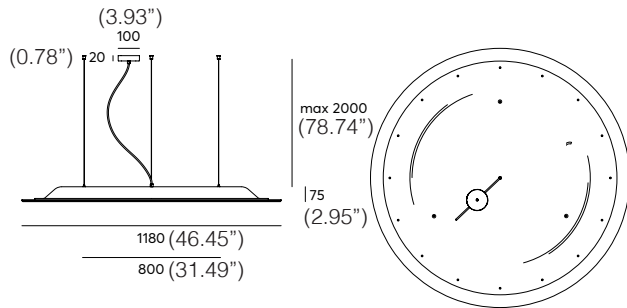

Material:

PET Felt (polyethylene terephthalate)

Fixture:

2m (78.74") black textile cable
3 black metal wires with adjustable griplock
Black ceiling cap and Charcoal PET Felt hood (standard)

Acoustic properties:



High absorption
value of aw 0,55

Pattern options:

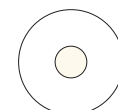

None

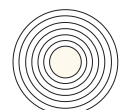

Circles

Total weight gross | net:

11,2 | 9,1kg

SPECIFICATION SHEET

ORDERING INFO

Model (Order Code)	Acoustic Finish Options	Pattern Options	LED	Dimming Options
<input type="radio"/> L77FLOAT RING L1200 Up&Downlight	<input type="radio"/> See Acoustic Finish Options on Next Page	<input type="radio"/> N: None	<input type="radio"/> 27: 2700K	<input type="radio"/> 120V LTE
<input type="radio"/> L77FLOAT RING L1200 Downlight		<input type="radio"/> C: Circles	<input type="radio"/> 30: 3000K	<input type="radio"/> 120-277V 0-10V (Universal Voltage)
			<input type="radio"/> 40: 4000K	



FLOAT™ RING L1200

SUSPENSION

TYPE:

PROJECT NAME:

Colors:



Light source specifications:







LED power:	35W
Luminous Flux:	3950lm
Frequency:	47-63Hz
Power factor:	113lm/W
Optics:	Acrylic Opal Prism
CRI:	Ra>90
UGR:	<22
Operatina temperature:	-20 ~ +45

Acoustic specifications:

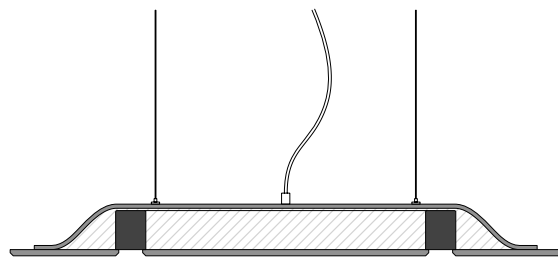
The acoustic design principle.

Measurement of sound absorption in a reverberation room
According to ISO 354:2003



-  Acoustic PET Felt
-  Air
-  LED Element

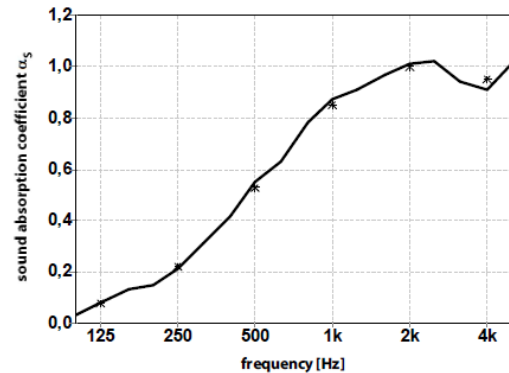

	125	250	500	1k	2k	4k
1/3 oct.	0.03	0.15	0.42	0.78	0.97	0.94
	0.08	0.21	0.55	0.87	1.01	0.91
	0.13	0.31	0.63	0.91	1.02	1.01
1/1 oct.	0,08	0,22	0,53	0,85	1,00	0,95

The product is designed to have a double layer sound absorbing PET Felt with 60 mm. of air cavity in between. Due to the layered effect, soundwaves are optimally absorbed by the design.

aw (ISO 11654) = 0,55(MH)

SAA (ASTM - C423) = 0,65

SPECIFICATION SHEET

FLOAT™ RING L1200

SUSPENSION - UPLIGHT

TYPE:

PROJECT NAME:



Light source specifications:



LED power:	17W
Luminous Flux:	1870lm
Frequency:	47-63Hz
Power factor:	110lm/W
Optics:	Acrylic Opal Prism
CRI:	Ra>80
UGR:	<25
Operating temperature:	-20 ~ +45

Photometrics:

Lumen intensity distribution

