

GAIA™

WALL LED

TYPE:

PROJECT NAME:

GAIA

WALL



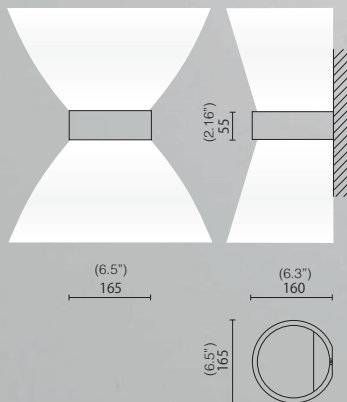



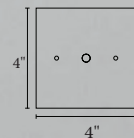

CODE	W	Lm
L25A9-650.30...	11	885



A ring diffusing a delicate light. Gaia is a double emission wall lamp made from epoxy polyester powder coated aluminium stabilized with UV rays and it is equipped with Chip On Board technology high efficiency LED light sources and driver. Its degree of protection against the penetration of dust, solid objects and liquids is IP20.

INSTALLATION NOTE:
Comes with 4" SQUARE backplate to cover the junction box



-  100°
-  TC 3000K
-  IP 20
-  CRI >80
-  EEI A+
-  RG 0
-  08 Satin white
- 

SPECIFICATION SHEET