

GRID™

MODULAR CEILING SYSTEM

TYPE:

PROJECT NAME:



GRID

Grid is an innovative modular surface mounted ceiling system. A very small composition or an infinite network of profiles can be placed from a single electrical connection and provide light wherever required. The strikingly graphic configurations form sculptures discretely and stylishly integrated into the architecture of each space. Grid features LED spots with a 45° beam angle for direct lighting.



SPECIFICATION SHEET

Luminart®

WWW.LUMINARTLIGHTING.COM

GRID™

MODULAR CEILING SYSTEM

TYPE:

PROJECT NAME:

BASE WITH DRIVER

4.52" 4.52"
115 MM 115 MM

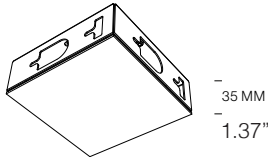

WATTAGE MAX. 4 SPOTS 4W

ORDER CODE

BLACK ANODIZED	L30T108C1DZL
WHITE PAINTED	L30T108C1DWL

Order one Base for every 4 lights.
Bases can be connected with connector pieces shown below.
Grid and Grid Globe use the same base and connectors,
so compositions can be made with both spot and globe lights.
See page 5 for composition examples.

GRID CONNECTION PIECE 50CM

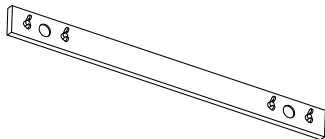

500 MM
19.68"

ORDER CODE

BLACK ANODIZED	L30T108P7DZL
WHITE PAINTED	L30T108P7DWL

GRID CONNECTION PIECE 75CM

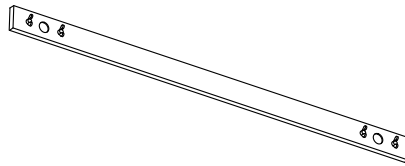

750 MM
29.52"

ORDER CODE

BLACK ANODIZED	L30T108P8DZL
WHITE PAINTED	L30T108P8DWL

GRID CONNECTION PIECE 100CM

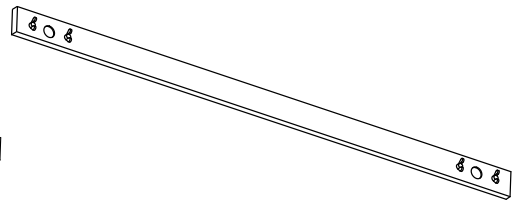

1000 MM
39.37"

ORDER CODE

BLACK ANODIZED	L30T108P9DZL
WHITE PAINTED	L30T108P9DWL

TYPE:

PROJECT NAME:

GRID ARM 1 WITH 1 SPOT

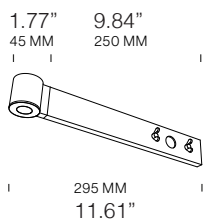

LAMP TYPE	LED
COLOUR TEMP.	2700K
WATTAGE	4W
LUMEN	400

ORDER CODE

BLACK ANODIZED	L30T108P1DZL
WHITE PAINTED	L30T108P1DWL

GRID ARM 2 WITH 1 SPOT

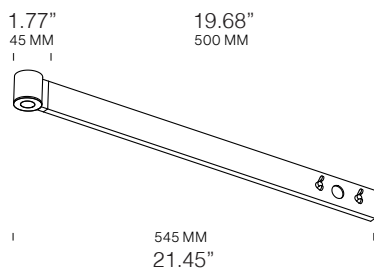

LAMP TYPE	LED
COLOUR TEMP.	2700K
WATTAGE	4W
LUMEN	400

ORDER CODE

BLACK ANODIZED	L30T108P2DZL
WHITE PAINTED	L30T108P2DWL

GRID ARM 3 WITH 1 SPOT

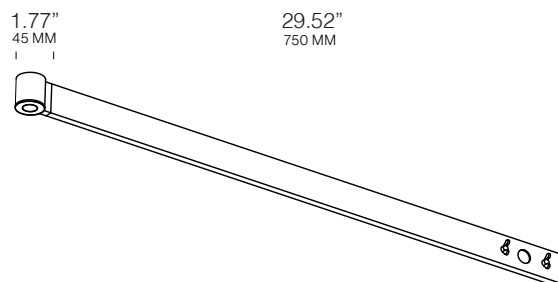

LAMP TYPE	LED
COLOUR TEMP.	2700K
WATTAGE	4W
LUMEN	400

ORDER CODE

BLACK ANODIZED	L30T108P3DZL
WHITE PAINTED	L30T108P3DWL

GRID ARM 1 WITH 2 SPOTS

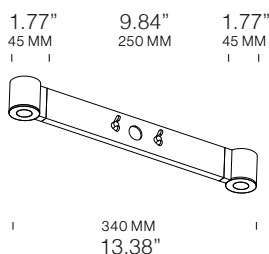

LAMP TYPE	LED
COLOUR TEMP.	2700K
WATTAGE	2x4W
LUMEN	2x400

ORDER CODE

BLACK ANODIZED	L30T108P4DZL
WHITE PAINTED	L30T108P4DWL

GRID ARM 2 WITH 2 SPOTS

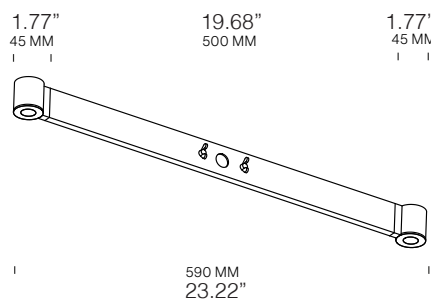

LAMP TYPE	LED
COLOUR TEMP.	2700K
WATTAGE	2x4W
LUMEN	2x400

ORDER CODE

BLACK ANODIZED	L30T108P5DZL
WHITE PAINTED	L30T108P5DWL

GRID ARM 3 WITH 2 SPOTS

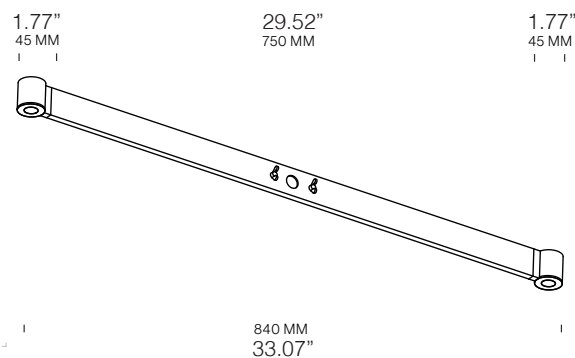

LAMP TYPE	LED
COLOUR TEMP.	2700K
WATTAGE	2x4W
LUMEN	2x400

ORDER CODE

BLACK ANODIZED	L30T108P6DZL
WHITE PAINTED	L30T108P6DWL

GRID™

MODULAR CEILING SYSTEM

TYPE:

PROJECT NAME:

ORDERING INFO

Driver Options

- 120V Phase Dimming
- 120V 0-10V Dimming



The Grid modular ceiling system can be designed in multiple configurations by using the different length of arms that are connected to the bases. The Grid allows the customer to create their own unique design.

Please ensure to order all the necessary components to complete your design. See examples on page 5 for different configuration ideas.

Order Code	Quantity
-	-
-	-
-	-
-	-
-	-
-	-
-	-
-	-
-	-
-	-
-	-
-	-
-	-
-	-
-	-
-	-
-	-
-	-
-	-

SPECIFICATION SHEET

TYPE:

PROJECT NAME:

EXAMPLES - HOW TO ORDER

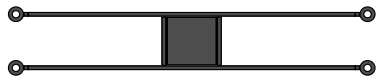

=

2x L30T108P6D
1x L30T108C1D

1x L30T108P1D
2x L30T108P2D
1x L30T108P3D
1x L30T108C1D

=

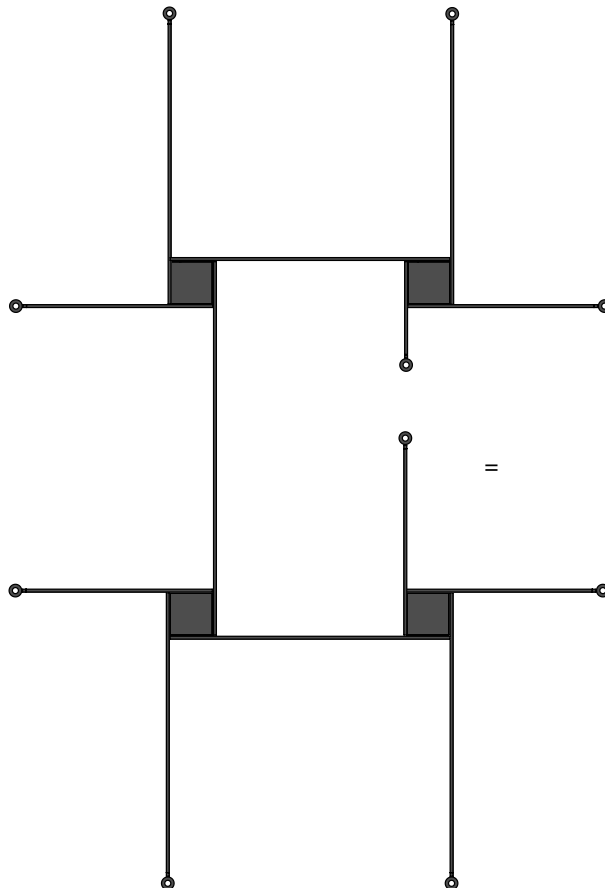
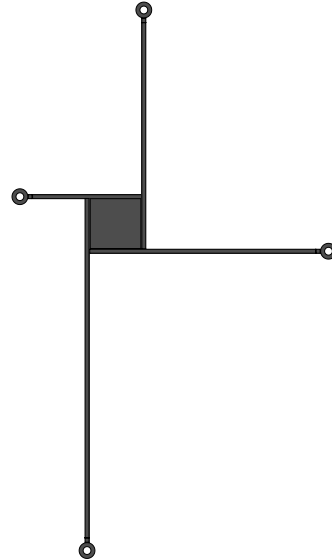

=

4x L30T108P3D
5x L30T108P2D
1x L30T108P1D
2x L30T08P8D
1x L30T108P9D
4x L30T108C1D