

# DA™ RECESSED LED



FKB7,

BDA <75F @3? 7,

## IRO

RECESSED

Refined and elegant, Iro is a recessed light made from die-cast aluminium and equipped with a frosted diffuser, a Chip On Board technology high efficiency LED light source and a remote driver. It is available in two sizes. Its degree of protection against the penetration of dust, solid objects and liquids is IP43.

	(see table)
TC	3000K
IP	43
CRI	>80
EEL	A+
RG	0
08	Satin white
D	Driver included
	Intertek

### IRO GRANDE

CODE	W	Lm	
L25A5-669.25.30	25	2200	95°

/DIMM2 DALI dimmer  
/DIMM3 DIM-switch dimmer

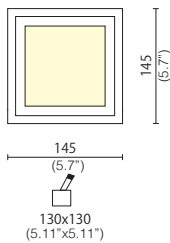
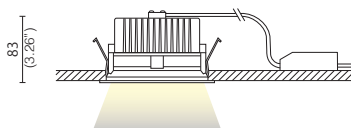

SPECIFICATION SHEET

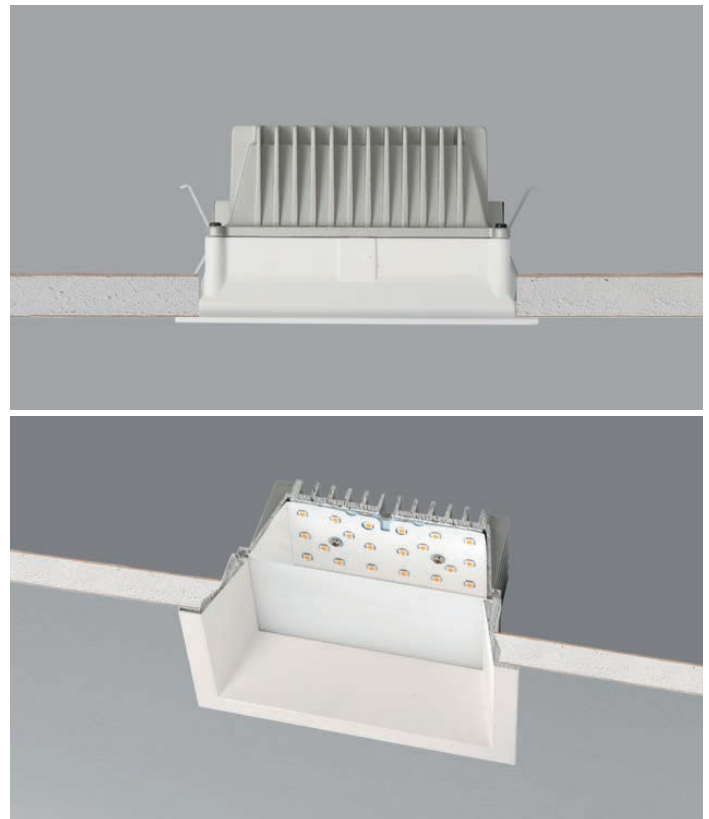

# IRO™

RECESSED LED

**TYPE:**

**PROJECT NAME:**



## IRO PICCOLO

CODE	W	Lm	
L25A5-668.11.30	11	950	85°

/DIMM2 DALI dimmer  
/DIMM3 DIM-switch dimmer

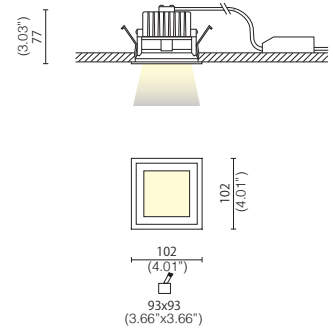

SPECIFICATION SHEET