

WASH™

Wall effect



WASH 22
LED



WASH 42
LED

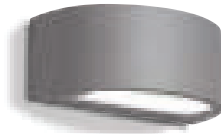

WASH 24
LED

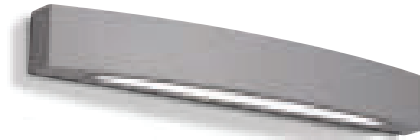

WASH 52
LED

WASH™

Wall effect

GENERAL FEATURES

- Outdoor wall-washer effect wall fitting.
- **Structure:** ultrawhite opal or transparent tempered glass diffuser. Low copper content die-cast aluminium body. Matching stainless steel screws.
- Available with double or single light that can be adjusted upward or downward.
- Version with asymmetric emission and clear glass with net light demarcation. Version with symmetrical light emission and opal glass.
- Low consumption **sources** and **new generation LEDs** with minimum life 50,000 h with subsequent deterioration max 30%. Driver inside.
- Cable entry from the back.
- **Finish:** on aluminium, pickling + phosphochrome + epoxy basic coating + UV resistant stabilised epoxy powder coating.
- Manufactured in compliance with European standards EN 60598-1:2015 CE

OPAL GLASS, LINEAR MODULE FOR A SOFT LIGHT

WASH: Opal glass to have a soft and comfortable light.

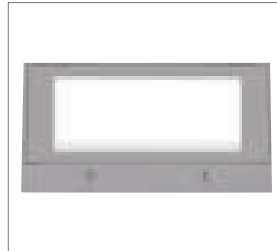

CLEAR GLASS + POWER LED FOR DIRECT LIGHT

Ultra-white clear glass and adjustable Asymmetric reflectors for a direct, sharp and incisive light.

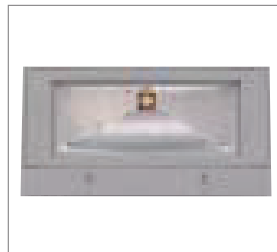

ADJUSTABLE ASYMMETRIC REFLECTORS

The Asymmetric reflector can be fixed in two different positions: against the wall to highlight the wall-washer effect or adjusted to illuminate balconies, walkways, corridors etc.

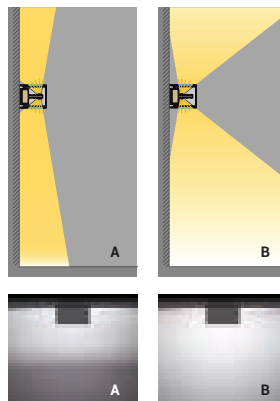

SIMPLE REFLECTOR ADJUSTMENT

It is quite simple to adjust the reflector: adjustment can be made even if the light is on. Unscrew, lift the reflector, turn 180° and screw.





TYPE: _____

PROJECT NAME: _____

WASH 22

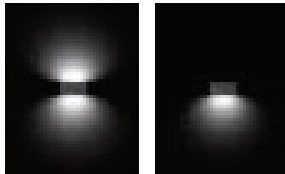
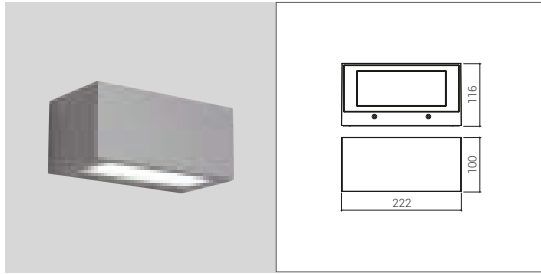

Opal glass + Linear Led Module

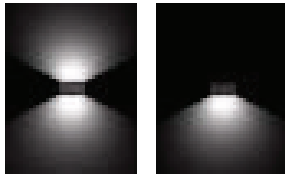

Ultra-white clear glass + asymmetric reflector and Power Led

CODE	LAMP	W	- Real output	GR	GM	BI
- Up + down light						
1301*	Led	2X9,3	2X1120 1394			
1302*	E 27 Dulux El	L max 176mm	18			
- Single light (up or down)						
1305*	Led	1X9,3	1120 513			
1306*	E 27 Dulux El	L max 176mm	18			

Marine die-cast aluminium alloy housing.
Milled opal glass - frame level.
IP 65 / Class I / IK 08
CRI 80 / Driver IN / 500 mA
230V / 50 Hz
CE
Dimmable on request. Emergency on request.
Standard 4000K. Other tonality on request. Add TC to the code if 3000K.

CODE	LAMP	W	Real output	GR	GM	BI
- Up + down light						
1308*	O Led	2x9,5	2x1200 1860			
- Single light (up or down)						
1309*	O Led	1X9,5	1x1200 930			

Ultra-white milled clear glass-frame level.
Asymmetric reflector suitable to double position.
IP 65 / Class I / IK 08
CRI 80 / Driver IN / 350 mA
230V / 50 Hz
CE
Standard 4000K. Other tonality on request. Add TC to the code if 3000K.

WASH 42

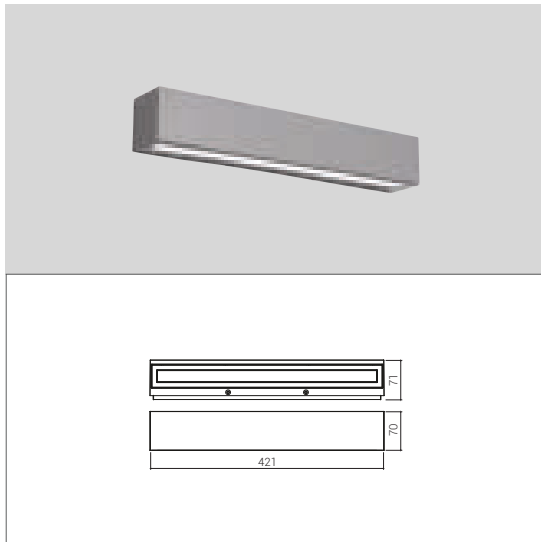

CODE	LAMP	W	Real output	GR	GM	BI
- Up + down light						
1311*	Led	2x11	2x1470 1280			
- Single light (up or down)						
1312*	Led	11	1470 640			

Milled Opal glass - frame level.
IP 65 / Class I / IK 08
CRI 80 / Driver IN / 700 mA
230V / 50 Hz
CE
Dimmable on request. Emergency on request.
Standard 4000K. Other tonality on request. Add TC to the code if 3000K.

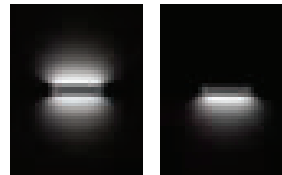

Opal glass + Linear Led Module



TYPE: _____

WASH 24

PROJECT NAME: _____

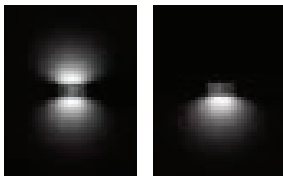
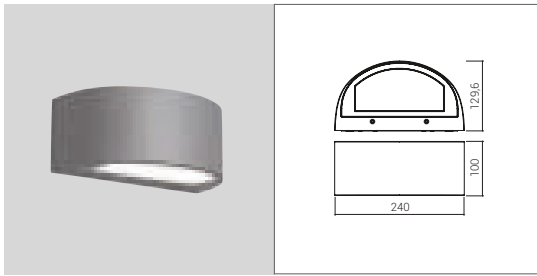

Opal glass + Linear Led Module

CODE	LAMP	W	- Real output	GR	GM	BI
- Up + down light						
1321*	Led	2X9,3	2X1120	1394		
1322*	E 27 Dulux El	L max 176mm	18			
- Single light (up or down)						
1324*	Led	1X9,3	1120	513		
1325*	E 27 Dulux El	L max 176mm	18			

Marine die-cast aluminium alloy housing.
Milled opal glass - frame level.
IP 65 / Class I / IK 08
CRI 80 / Driver IN / 500 mA
230V / 50 Hz
CE
Dimmable on request. Emergency on request.
Standard 4000K. Other tonality on request. Add TC to the code if 3000K.

CODE	LAMP	W	Real output	GR	GM	BI
- Up + down light						
1327*	O Led	2x9,5	2x1200	1860		
- Single light (up or down)						
1328*	O Led	1X9,5	1x1200	930		

Ultra-white milled clear glass-frame level.
Asymmetric reflector suitable to double position.
IP 65 / Class I / IK 08
CRI 80 / Driver IN / 350 mA
230V / 50 Hz
CE
Standard 4000K. Other tonality on request. Add TC to the code if 3000K.

WASH 52

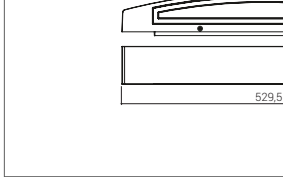
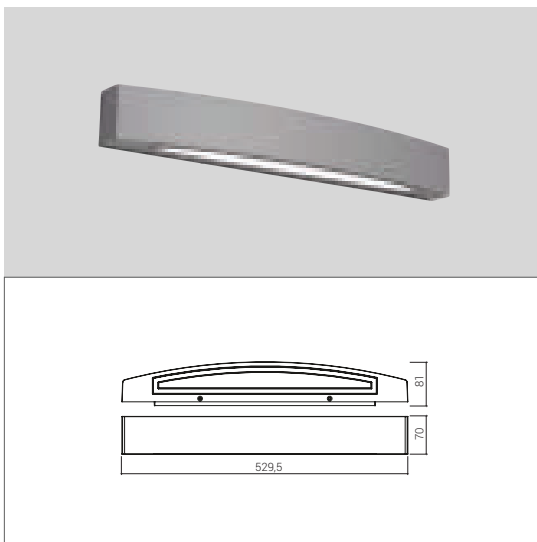

Opal glass + Linear Led Module

CODE	LAMP	W	Real output	GR	GM	BI
- Up + down light						
1332*	Led	2x11	2x1470	1394		
- Single light (up or down)						
1333*	Led	11	1470	698		

Milled Opal glass - frame level.
IP 65 / Class I / IK 08
CRI 80 / Driver IN / 700 mA
230V / 50 Hz
CE
Dimmable on request. Emergency on request.
Standard 4000K. Other tonality on request. Add TC to the code if 3000K.