

BLOK™

BOLLARD

TYPE:

PROJECT NAME:

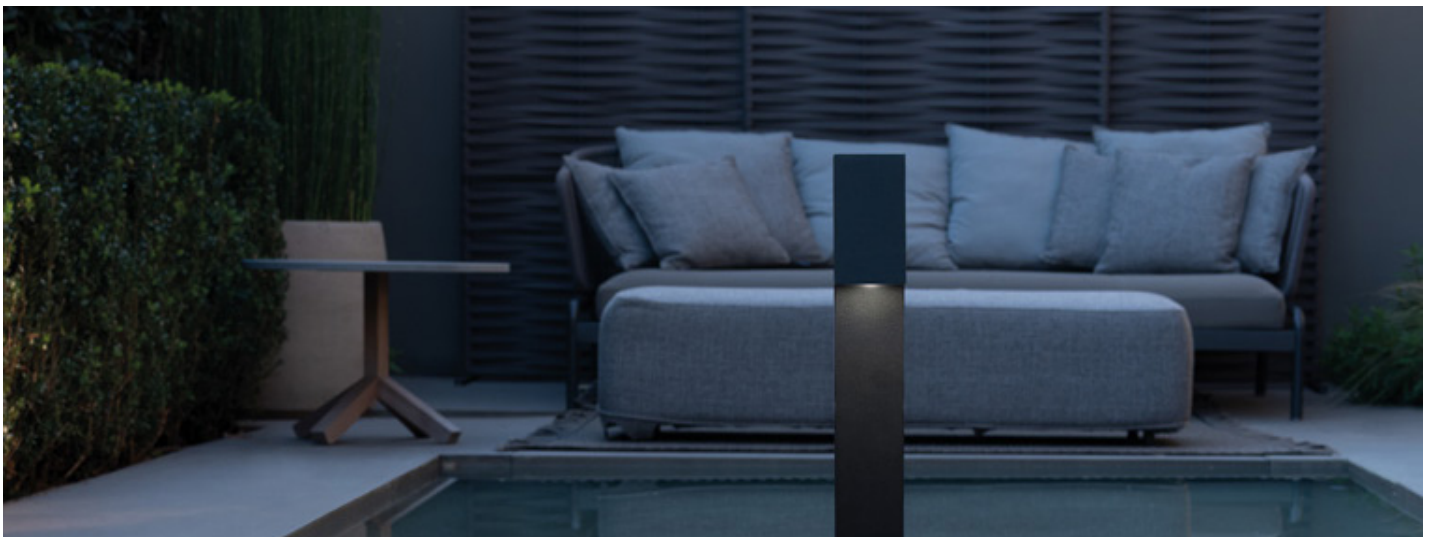

SPECIFICATION SHEET

BLOK™

BOLLARD

TYPE:

PROJECT NAME:

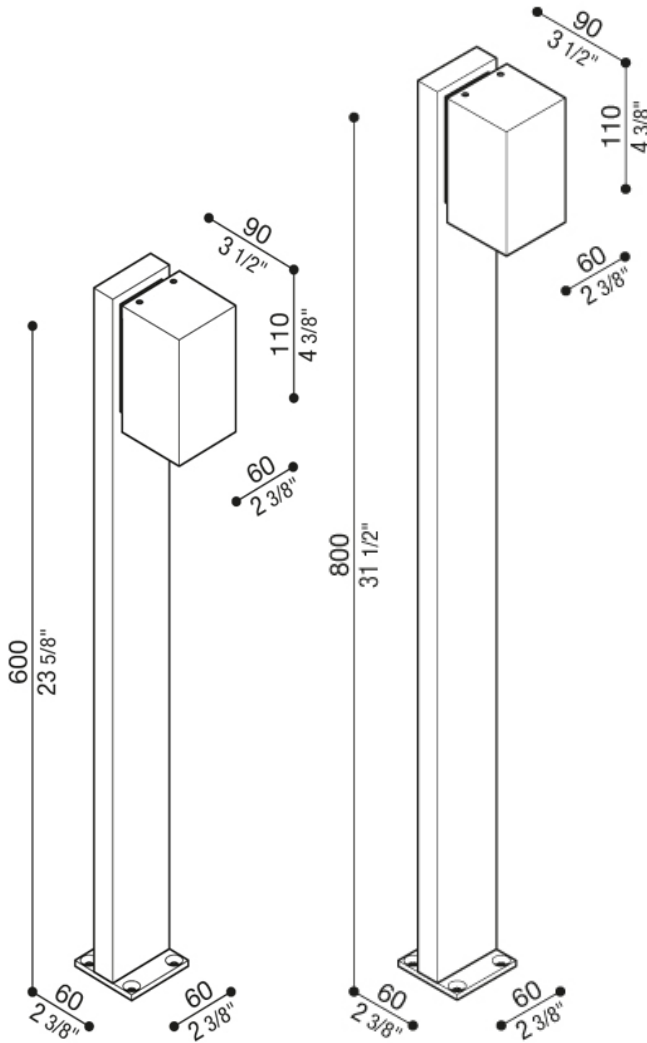

Technical information:

Installation:	Ground
Material:	Aluminum
Treatment:	Sea Treatment
Diffuser type:	Serigraphed Glass
CRI:	>80
LB Factor:	L80B20 - 50.000h
Power consumption [Watt]	3
Source Lumen:	500 lm
Delivered Lumen:	260 lm
Type of protection:	IP66

SPECIFICATION SHEET

ORDERING INFO

Model (Order Code)	Structure Finish	Height Options	Optic Options	LED	Dimming Options
<input type="radio"/> L53BLOK BOLLARD	<input type="radio"/> WH: White RAL9010 <input type="radio"/> CO: Corten <input type="radio"/> AN: Anthracite RAL7021 <input type="radio"/> GR: Grey RAL9006	<input type="radio"/> 60: 600mm (23.62") <input type="radio"/> 80: 800mm (31.49")	<input type="radio"/> Diffuse <input type="radio"/> Transparent	<input type="radio"/> 2700K <input type="radio"/> 3000K <input type="radio"/> 4000K	<input type="radio"/> 120V LTE <input type="radio"/> 120V 0-10V <input type="radio"/> 277V 0-10V



*See Details on the next page.

Luminart®

WWW.LUMINARTLIGHTING.COM
Last updated: 04/22/24

Trend H600 Optic

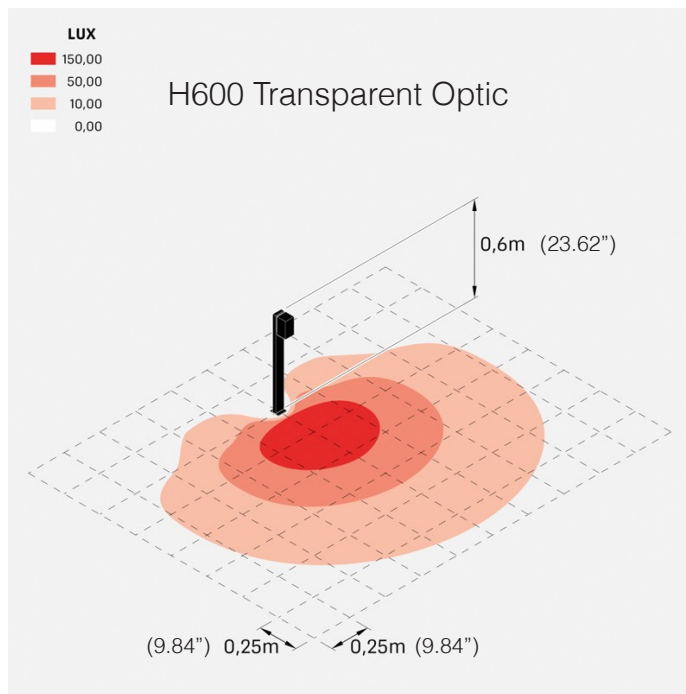
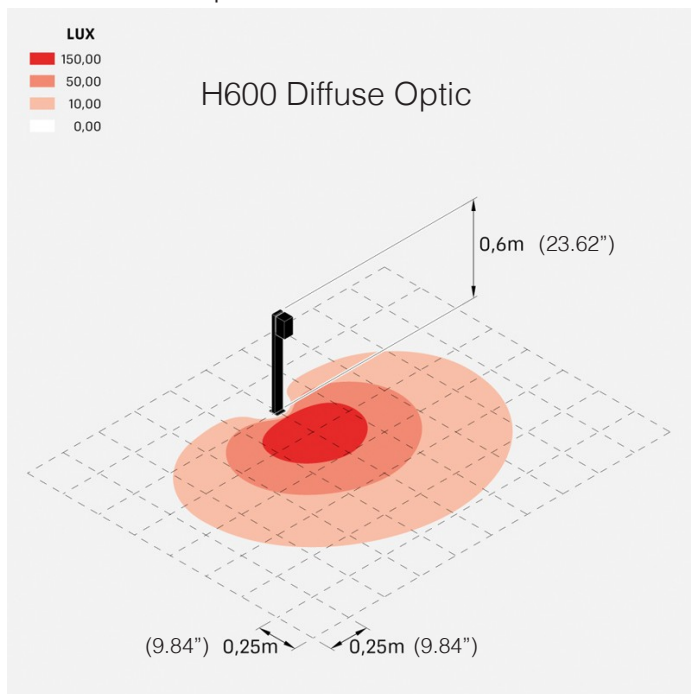

Trend H800 Optic

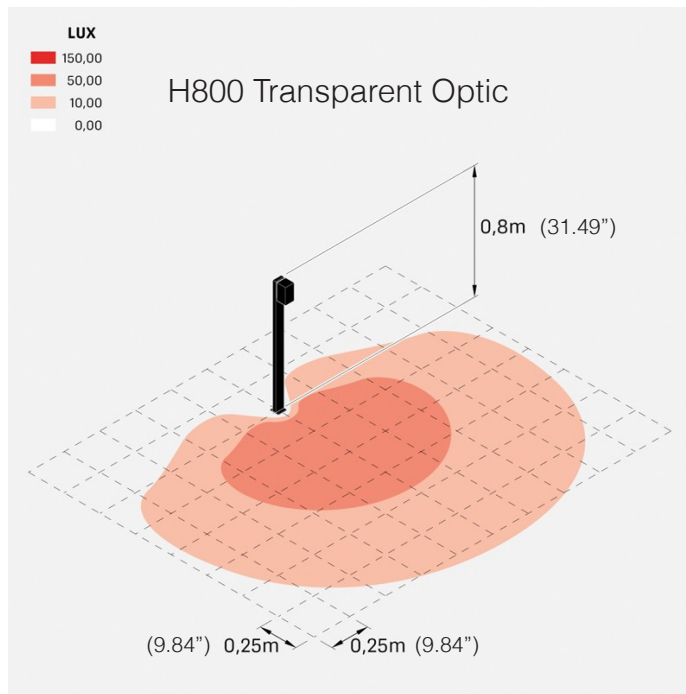
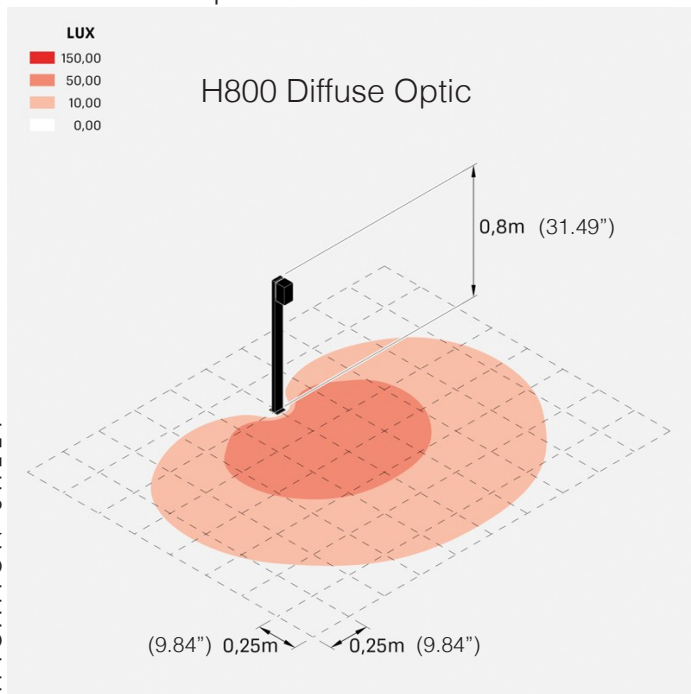

Trend H600 Photometric Curves

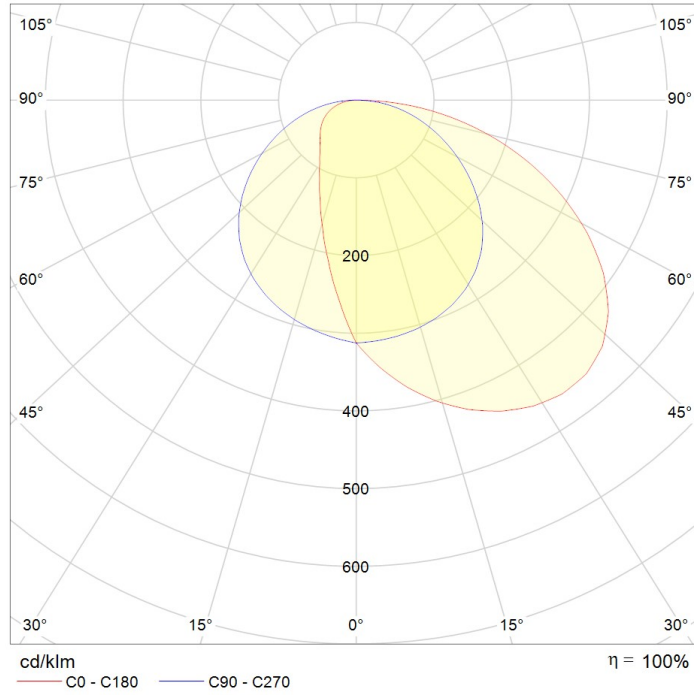

Trend H800 Photometric Curves

