

MACARON™

SUSPENSION

TYPE:

PROJECT NAME:



SPECIFICATION SHEET

MACARON™ S450

SUSPENSION

TYPE:

PROJECT NAME:



Macaron light pendant 450

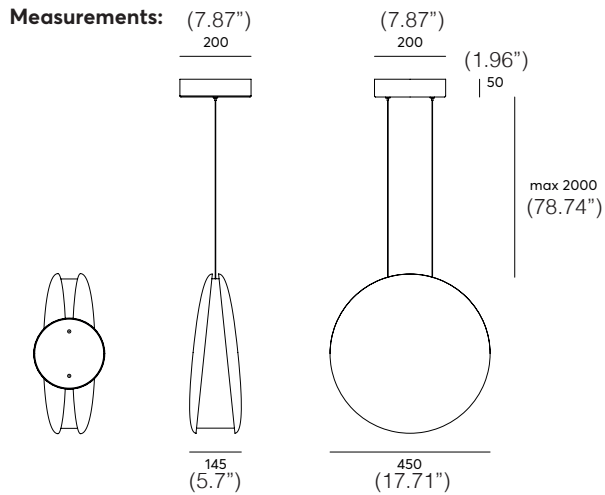

Material:

PET Felt (polyethylene terephthalate)

Fixture:

2 black metal wires with adjustable griplock
 Black ceiling cap

Acoustic properties:



High absorption
 value of α_w 0,85

Total weight: 2,9kg

SPECIFICATION SHEET

ORDERING INFO

MACARON S450	-	-	-	-
Model (Order Code)	Inside Acoustic Options	Outside Acoustic Options	LED	Dimming Options
<input type="radio"/> MACARON S450	<input type="radio"/> See Acoustic Finish Options on Next Page	<input type="radio"/> See Acoustic Finish Options on Next Page	<input type="radio"/> 27: 2700K <input type="radio"/> 30: 3000K <input type="radio"/> 40: 4000K	<input type="radio"/> 120V LTE <input type="radio"/> 120V-277V 0-10V (Universal Voltage)



MACARON™ S450

SUSPENSION

TYPE:

PROJECT NAME:

Inside Finish:

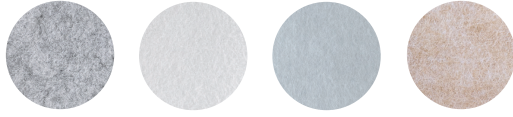

11_Fog Grey 07_Ghost White 30_Cool Grey 04_Bisque

Outside Finish:

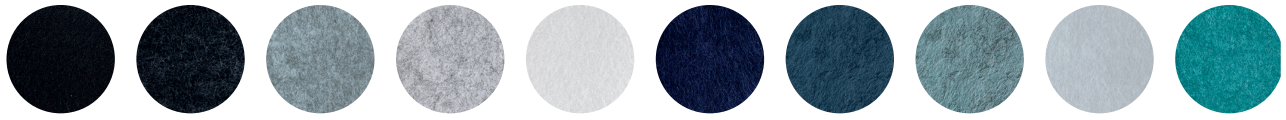

13_Black 03_Charcoal 36_Dim Grey 11_Fog Grey 07_Ghost White 19_Midnight 26_Ocean 42_Rock Blue 30_Cool Grey 12_Turquoise

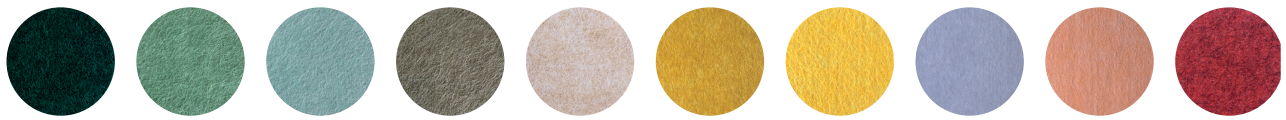

17_Forest 40_Faded Jade 41_Mint Pastel 39_Warm Grey 04_Bisque 35_Ochre 05_Lemon 09_Lavender 31_Rosé 45_Chilli

Light source specifications:



LED power: 30W
 Luminous Flux: 1440lm
 Frequency: 47-63Hz
 Power factor: 48lm/W
 Optics: Acrylic diffuser
 CRI: Ra>90
 UGR: <10
 Operating temperature: -20 ~ +45

Acoustic specifications:

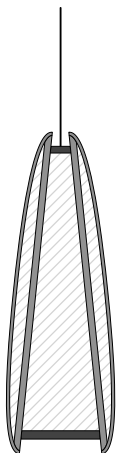

■ Acoustic PET Felt
 ▨ Air
 ■ LED Element

The product is designed with multiple layers of sound absorbing PET Felt and an air cavity in between. Because of the layered effect, the soundwaves are optimally absorbed by the fixture.

The LED element will reflect the soundwaves.

Measurement of sound absorption in a reverberation room According to ISO 354:2003

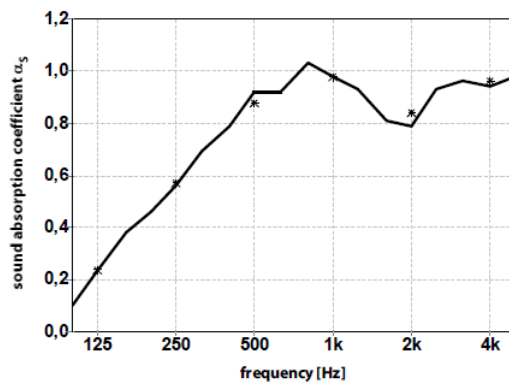

1/3 oct.	0,10	0,46	0,79	1,03	0,81	0,96
	0,23	0,56	0,92	0,98	0,79	0,94
	0,38	0,69	0,92	0,93	0,93	0,98
1/1 oct.	0,24	0,57	0,88	0,98	0,84	0,96

aw (ISO 11654) = 0,85 (H)

SAA (ASTM - C423) = 0,82

SPECIFICATION SHEET

MACARON™ M600

SUSPENSION

TYPE:

PROJECT NAME:



Measurements:

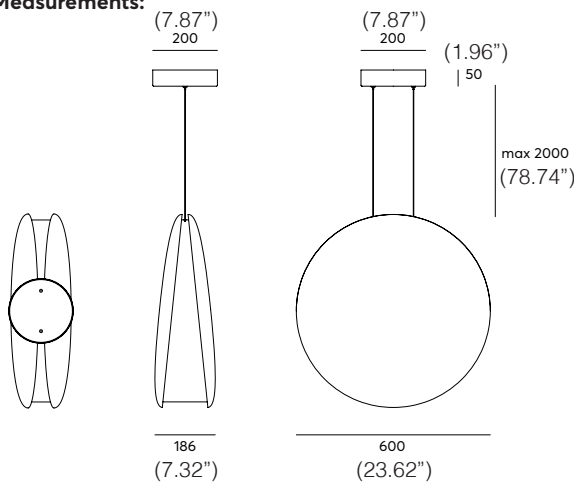

Material:

PET Felt (polyethylene terephthalate)

Fixture:

2 black metal wires with adjustable griplock
Black ceiling cap

Acoustic properties:



High absorption
value of aw 0,85

Total weight: 4,0kg

SPECIFICATION SHEET

ORDERING INFO

MACARON S450	-	-	-	-
Model (Order Code)	Inside Acoustic Options	Outside Acoustic Options	LED	Dimming Options
<input type="radio"/> MACARON M600	<input type="radio"/> See Acoustic Finish Options on Next Page	<input type="radio"/> See Acoustic Finish Options on Next Page	<input type="radio"/> 27: 2700K <input type="radio"/> 30: 3000K <input type="radio"/> 40: 4000K	<input type="radio"/> 120V LTE <input type="radio"/> 120V-277V 0-10V (Universal Voltage)



MACARON™ M600

SUSPENSION

TYPE:

PROJECT NAME:

Inside Colors:

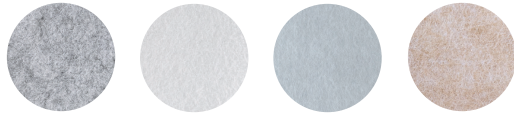

11_Fog Grey 07_Ghost White 30_Cool Grey 04_Bisque

Outside Colors:

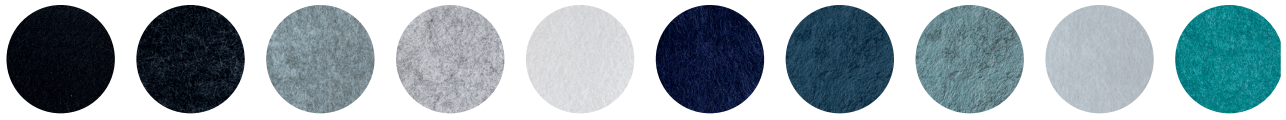

13_Black 03_Charcoal 36_Dim Grey 11_Fog Grey 07_Ghost White 19_Midnight 26_Ocean 42_Rock Blue 30_Cool Grey 12_Turquoise

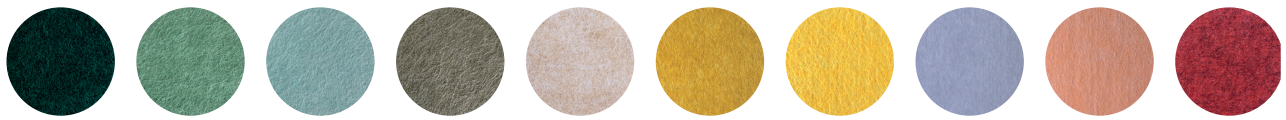

17_Forest 40_Faded Jade 41_Mint Pastel 39_Warm Grey 04_Bisque 35_Ochre 05_Lemon 09_Lavender 31_Rosé 45_Chilli



Light source specifications:

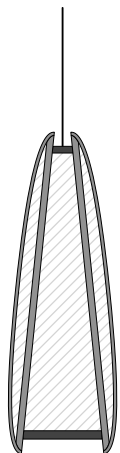

LED power:	42W
Luminous Flux:	1950lm
Frequency:	47-63Hz
Power factor:	46,5lm/W
Optics:	Acrylic diffuser
CRI:	Ra>90
UGR:	<10
Operating temperature:	-20 ~ +45

Acoustic specifications:



-  Acoustic PET Felt
-  Air
-  LED Element

The product is designed with multiple layers of sound absorbing PET Felt and an air cavity in between. Because of the layered effect, the soundwaves are optimally absorbed by the fixture.

The LED element will reflect the soundwaves.

Measurement of sound absorption in a reverberation room According to ISO 354:2003

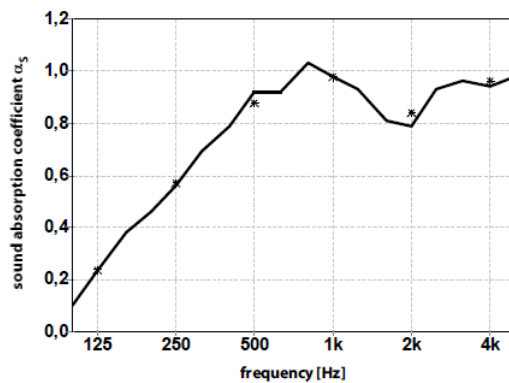

1/3 oct.	0,10	0,46	0,79	1,03	0,81	0,96
	0,23	0,56	0,92	0,98	0,79	0,94
	0,38	0,69	0,92	0,93	0,93	0,98
1/1 oct.	0,24	0,57	0,88	0,98	0,84	0,96

aw (ISO 11654) = 0,85 (H)

SAA (ASTM - C423) = 0,82

SPECIFICATION SHEET