

WETT™ RGB

RECESSED INGROUND SUBMERSIBLE

TYPE:

PROJECT NAME:

LIGHTING FEATURES

LED COLOUR	RGBW
OPTICS	36°, 60°, Diffused
AVERAGE LED LIFE	50.000h L80 B10

MECHANICAL FEATURES

WEIGHT	kg 0,55
FINISHES	Steel

INSTALLATION

Recessed in ground with housing box,
recessed in brickwork with housing box,
installation out of water with standard housing box,
permanent immersion installation with IP68 housing box

MATERIAL

AISI 316L stainless steel body, AISI 316L stainless steel trim, transparent tempered glass and PMMA lens

GENERAL FEATURES

OPERATING TEMPERATURE	-10°C +45°C
INGRESS PROTECTION	IP68
IMPACT RESISTANCE	IK08
GLOW WIRE TEST	960°C
APPLIANCE CLASS	II

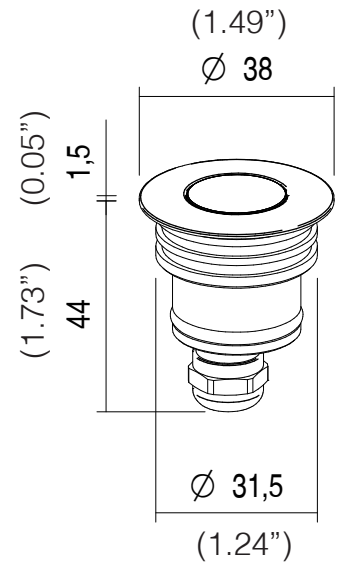

ORDERING INFO

Model (Order Code)	Structure Finish	Optic Options	Accessories	Filter Options	LED	Remote Driver
<input type="radio"/> WETT RGB 1.6W	<input type="radio"/> S: AISI 316L Stainless Steel Marine Grade	<input type="radio"/> 36: 36° <input type="radio"/> 60: 60° <input type="radio"/> D: Diffused	<input type="radio"/> CA832: Housing Box <input type="radio"/> CAW32: Housing Box <input type="radio"/> CAI32: Housing Box	<input type="radio"/> HC: Honeycombo	<input type="radio"/> RGB	<input type="radio"/> 120V LTE <input type="radio"/> 120-277V 0-10V

SPECIFICATION SHEET



WETT™ RGB

RECESSED - ACCESSORIE

TYPE:

PROJECT NAME:

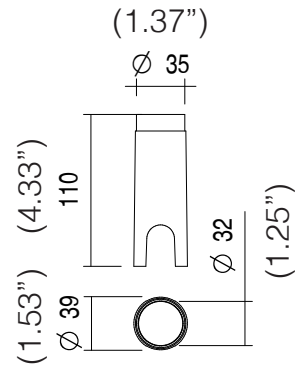

to be chosen

CODE	CAW32
TPOLOGY	Housing box  kg 0,09
MATERIAL	PVC

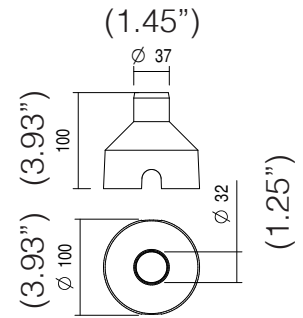

CODE	CAI32
TPOLOGY	Housing box  kg 0,06
MATERIAL	ABS



CODE	CA832
TPOLOGY	IP68 Housing box   kg 0,06
MATERIAL	PVC

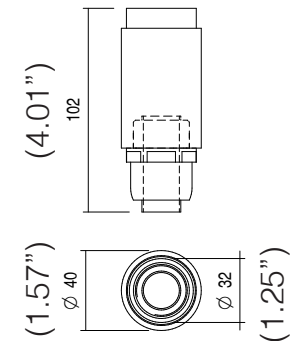

SPECIFICATION SHEET

WETT™ RGB

RECESSED - FILTER

TYPE:

PROJECT NAME:

<i>CODE</i>	HC
<i>TPOLOGY</i>	<i>Honeycomb filter</i>
NOTE	<i>with 10°, 36°, 60°, 10°x 55° lens only</i>

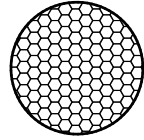

SPECIFICATION SHEET