

POP™ 04 Ø8 TRIMLESS

RECESSED

TYPE:

PROJECT NAME:



Mounting	Ceiling Recessed
Material	Metal body
LED	2700K, 3000K, 4000K
Dimmer	LTE / 0-10V
Ingress Protection	IP40
CRI	>95
Class	II
Lifetime	100.000h L80B10

- 02 White
 06 Black

Power	13.4W	
Luminaire Light Flux	2700K	1650lm
	3000K	1727lm
	4000K	1786lm

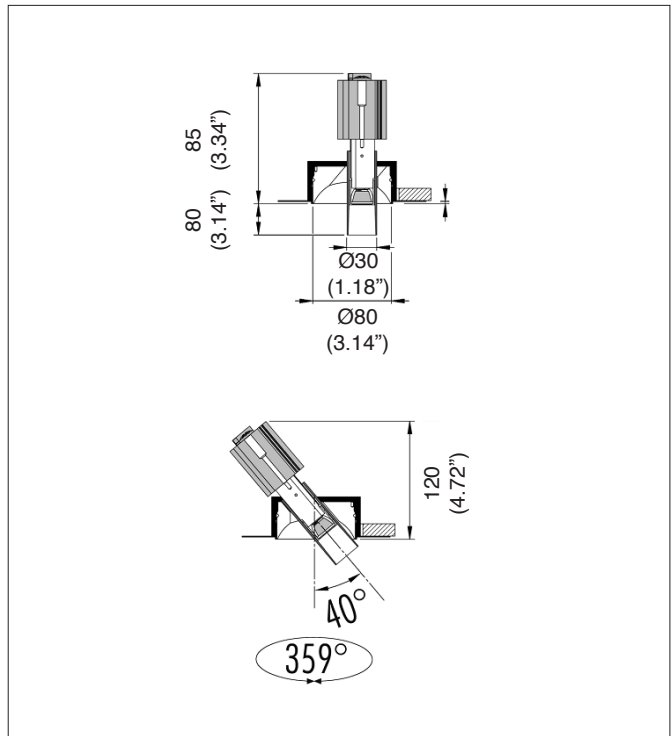
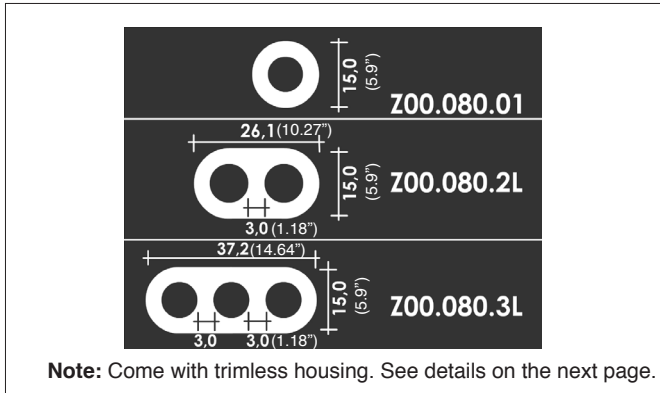

ORDERING INFO

Model (Order Code)	Finish Options	Optic Options	Housing	LED	Remote Driver Options
<input type="radio"/> L173P04.2 without Honeycomb	<input type="radio"/> 02: White	<input type="radio"/> 1: 25°	<input type="radio"/> Single: Z00.080.01	<input type="radio"/> 2: 2700K	<input type="radio"/> LTE: 120V LTE
<input type="radio"/> L174P04.2 with Honeycomb	<input type="radio"/> 06: Black		<input type="radio"/> Double: Z00.080.2L	<input type="radio"/> 3: 3000K	<input type="radio"/> D10: 120-277V 0-10V
			<input type="radio"/> Triple: Z00.080.3L	<input type="radio"/> 4: 4000K	

SPECIFICATION SHEET



POP™ 04 Ø8 TRIMLESS

RECESSED

TYPE:

PROJECT NAME:

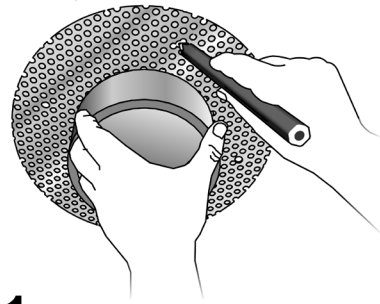

1

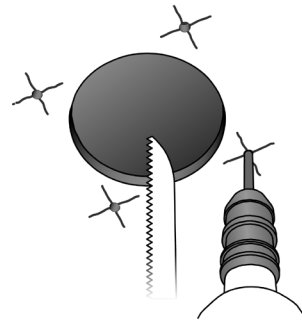

2

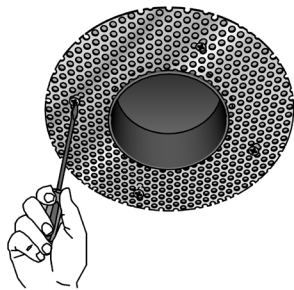

3

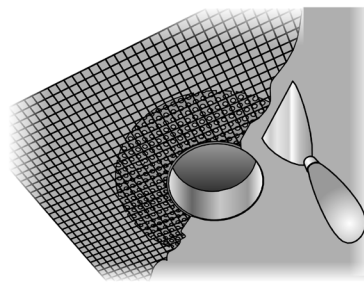

4

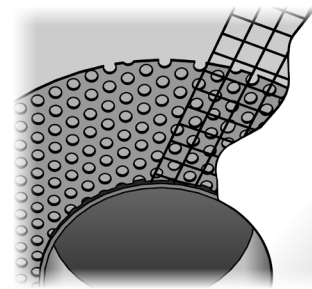

5

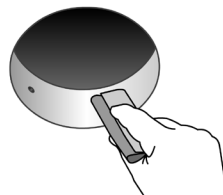

6

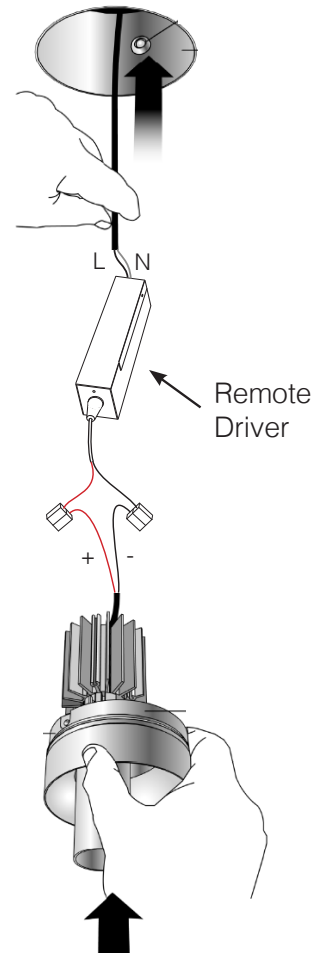
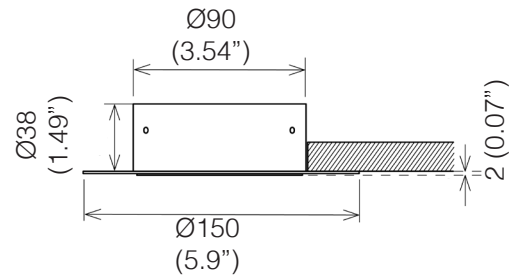
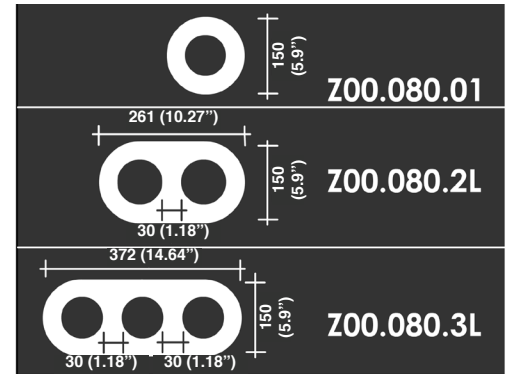

SPECIFICATION SHEET

- Once pointed the position of the lamp, mark the fixing holes for the housing.
- Make the hole for the housing and the holes for the fixing rawlplugs.
- Fix the screws of the housing to the ceiling plaster board.
- Apply the proper grasping net.
- Plaster and trim the compensating 2mm (0.07") gap.
- Keep clean the inside of the housing.